

# T A G

## PIPE EQUIPMENT SPECIALISTS LTD PIPE TOOLS CATALOGUE

### PIPE ALIGNMENT CLAMPS



### PIPE STANDS & ROLLERS



### PIPE PURGING EQUIPMENT



### PURGE MONITORS



### LAYOUT & MARKING TOOLS



### PIPE STOPPERS



MADE IN UK

ENGLISH



## PIPE EQUIPMENT SPECIALISTS LTD



### About Us

With headquarters in the UK, TAG-PIPE was founded by Anthony Tagliaferro who started in the manufacture and supply of pipework fabrication machinery, tools and handling equipment in 1985, having previously worked as a welder, fabricator and toolmaker.

Over recent years TAG-PIPE has grown significantly through focusing on the importance of being close to our customers. In 2012 we opened a branch in Europe (Belgium), in 2013 a branch in the USA (Houston), in 2014 a branch in Asia (China), in 2015 a branch in Middle East (Dubai) in 2016 a branch in India (Pune) and most recently in 2017 a branch in Vietnam (Ho Chi Minh City).

Today, with offices and warehousing in 7 countries, on 4 continents, 70 employees and more than 180 partnerships and distributors worldwide, we pride ourselves in consistently offering the highest standard of both product quality and service to all our customers.

We look forward to welcoming you into our global network as a TAG-PIPE partner, distributor or end user customer and remain at your disposal at any time.

### Products

TAG-PIPE is extremely proud to be established and recognised as one of the world's leading manufacturers and suppliers of:

- Pipe Beveling Machines
- Pipe Cold Cutting Machines
- Pipe Flame Cutting and Beveling Machines
- Pipe Alignment/Welding Clamps
- Pipe Jack Stands
- Pipe Purging Equipment
- Pipe Tools
- Pipe Stoppers
- Plate Beveling Machines

### Mission Statement

*"At TAG-PIPE we aim to offer our customers a comprehensive, top quality, competitive and unrivalled range of pipework machinery and tools, this backed with great customer service supported by our 6 branches strategically located on 4 continents and our extensive and continuous expanding global network of partners and distributors."*

**Aidan Tagliaferro, Managing Director**

### Industries

Our products are used in both workshop and on-site environments across various Industries worldwide including:

- Oil & Gas
- Pipelines
- General Fabrication
- Offshore Welding
- Ship Building
- Vessel Manufacturing
- Power Generation
- Boiler Industry
- Petrochemical
- Pharmaceutical
- Refineries
- Turbine
- Nuclear
- Heat Exchangers
- Dairy, Food and Beverages and many more...



[www.TAG-PIPE.com](http://www.TAG-PIPE.com)

*Our company policy is one of continuous improvement. Products may change or vary from those illustrated.*



## Customer Service

We work extremely hard supporting and training our team of employees and network of partners and distributors to ensure that from TAG-PIPE you always receive the:

- Fastest Response Times
- Quickest Delivery Times
- Most Knowledgeable and Accurate Advice
- Committed After Sales Support



## Level of Stock

TAG-PIPE carry an unrivalled stock level, meaning no matter how large your order we expect to offer you the fastest delivery time available worldwide.

## Price

You will find our pricing to be very competitive. Give us an opportunity to quote your next project and we are confident you will be pleased! For your convenience we offer our products in the three major currencies: US Dollars, Euros and GB Pound.

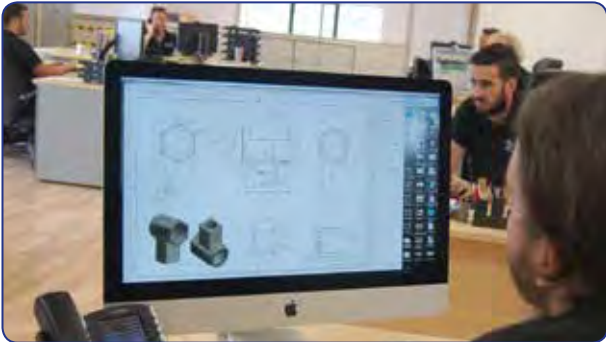

## Research and Development

Technology is always improving. At TAG-PIPE we firmly intend to move with the times and to be the trendsetters in our industry with a dedicated team of designers and technicians devoted to improving our existing products as well as innovating the next generation of pipework machinery and tools.



## Production, Assembly and Quality Control

With manufacturing partners in UK, Belgium and Italy, TAG-PIPE are proud to offer the highest quality of components manufactured wholly in Europe. All our machines are assembled in our UK facility and undergo vigorous testing and quality control, which is backed by our products being CE Certified, having Certificates of Conformity, UK Certificate of Origin and our company being ISO9001 accredited.



## Demonstrations and Training

We love to show off our products unrivalled performance and are always happy to carry out demonstrations either in our showroom facility in the UK or at your site. In addition we understand the importance of the correct operation of our machinery and tools so also offer training packages again either in our UK training facility or at your site ensuring safe, efficient and accurate operation.



## Rental Division

TAG-PIPE operates a Full, Worldwide Hire and Rental Service. With currently more than 300 machines, our hire fleet is constantly expanding. A large investment was made in 2016 with additional machinery as well as a new tailored hire software system to simplify all of your hire needs making us the best stop for all your pipework equipment rental needs.

**Please contact our designated Hire Department via any of these means: Tel: +44 (0) 1869 324 144 or E-mail: [hire@tag-pipe.com](mailto:hire@tag-pipe.com)**



## PIPE EQUIPMENT SPECIALISTS LTD

<b>Pipe Alignment Clamps.....</b>	<b>5</b>	<b>Pipe Purging Equipment .....</b>	<b>33</b>
E-Z Fit Red.....	6	Why Purge? .....	34
E-Z Fit Gold .....	7	Purge Bag System .....	36
E-Z Fit Single Chain Clamps.....	8	Rapid Purge™ System .....	38
E-Z Fit Mini Chain Clamps.....	9	Heat Resistant Purging Systems .....	40
E-Z Fit Double Chain Clamps.....	10	Double Seal Systems.....	42
E-Z Fit Internal Spider Clamps .....	12	Flange Double Seal Systems .....	44
Cage Clamps .....	14	Gas Cylinders .....	45
Rim Clamps.....	16	Handy Purge 100 Self Calibrating Weld Purge Monitor..	46
<b>Pipe Stands &amp; Rollers.....</b>	<b>17</b>	Handy Purge Pro 5 Weld Purge Monitor .....	48
Tri Stands .....	18	Pro Purge 1 Weld Purge Monitor.....	49
Duo Stands .....	20	Trailing Shields.....	50
Quattro Stands .....	22	<b>Pipe Stoppers .....</b>	<b>51</b>
Uno Stands .....	24	Pipe Stoppers .....	52
Tri Chain Vice Stand.....	24	Inflatable Pipe Stoppers .....	54
Mega Pipe Stand 3 Ton .....	25	Custom Stoppers .....	56
Mega Pipe Stand 5 Ton .....	25	<b>Layout &amp; Marking Tools .....</b>	<b>57</b>
Mega Pipe Stand 8 Ton .....	26	Rotary Earth Clamp .....	58
Mega Pipe Block .....	26	Wrap-a-round Pipe Wraps.....	58
High Pipe Stand .....	27	Fit Pins.....	59
Pipe Cart.....	27	Magnetic Universal Level .....	59
Pipe Buggy.....	28	Centering Head.....	59
Pipe Dolly .....	28	Contour Marker.....	60
Pipe Cradles & Slings.....	29	Radius Marker .....	60
Roller Stands.....	29	Flange Square.....	60
Roller Stands.....	30	Handy Point Plus Tungsten Grinder.....	61
Quick Change Rollers.....	30	Pro Point Plus Tungsten Grinder.....	62
Pipe Rack Rollers .....	31	<b>Other Products Include.....</b>	<b>63</b>
Pipe Launchers .....	32		
1 Ton Pipe Rotator .....	32		





PIPE EQUIPMENT SPECIALISTS LTD

## PIPE ALIGNMENT CLAMPS

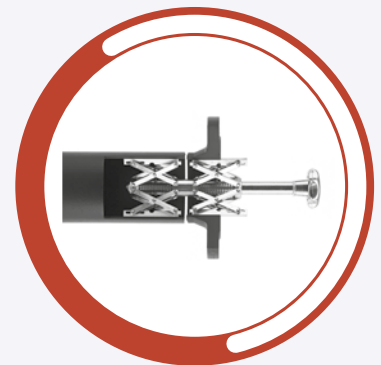

- Quick and E-Z to use
- Ultra robust design, ideal for site work
- Stainless steel contact points as standard
- Sliding T-bar Handle for ease of use and secure clamping
- Fine adjustment screws for quick fit-up
- Lightweight for overhead work



### Sizes Available

PART NO.	PIPE DIAMETER RANGE (INCH)	PIPE DIAMETER (MM)	CLAMP WEIGHT (KG / LBS)
EZR2	1 - 2.5"	25 - 74mm	1.5kg / 3.5lbs
EZR6	2 - 6"	50 - 170mm	4.0kg / 9.0lbs
EZR12	5 - 12"	127 - 325mm	6.7kg / 15.0lbs

### Working On Stainless Steel?

The new E-Z Fit Red Pipe Clamp can be used on stainless steel without any additional accessories due to the stainless steel feet and balls in the wing-nuts, preventing contamination of the pipe.

### E-Z Fit Red Typical Applications



**WARNING:** These E-Z Red clamps must not be used as a lifting device, as this may result in damage or injury

- Quick and E-Z to use
- Forged steel construction for maximum strength
- Combines accuracy with safety
- Instant centering
- Five size range options
- Wing bolts with stainless steel bearings

### Optional Extras

Stainless steel covers can be fitted quickly to the clamping feet. This makes all contact points of the clamp stainless, thus eliminating contamination of the pipe.

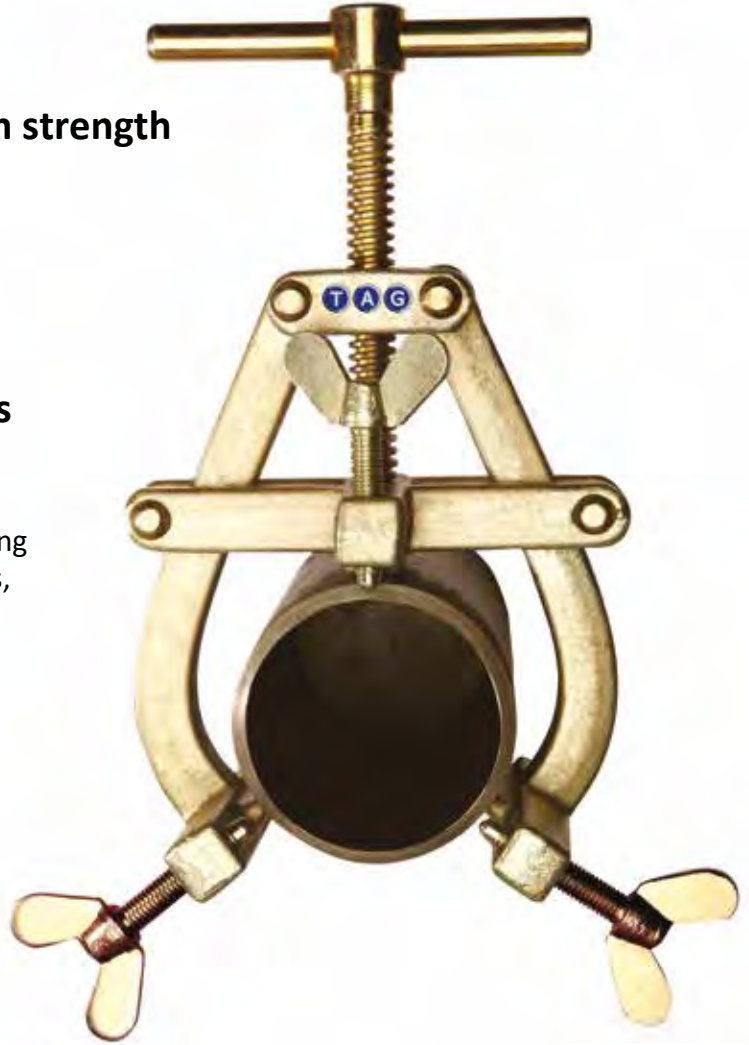

### Sizes Available

PART NO.	PIPE DIAMETER RANGE (INCH)	PIPE DIAMETER (MM)	CLAMP WEIGHT (KG / LBS)
EZG3	1 - 3"	20 - 90mm	1.4kg / 3lbs
EZG5	2 - 5"	50 - 150mm	3kg / 7lbs
EZG7	3 - 7"	90 - 195mm	3.3kg / 7.5lbs
EZG9	5 - 9"	125 - 245mm	7kg / 15.5lbs
EZG14	9 - 14"	225 - 370mm	9kg / 20lbs

### Stainless Steel Covers & Screws

PART NO.	PIPE CLAMP SIZE (INCH)
EZG3SS	1 - 3"
EZG5SS	2 - 5"
EZG7SS	3 - 7"
EZG9SS	5 - 9"
EZG14SS	9 - 14"

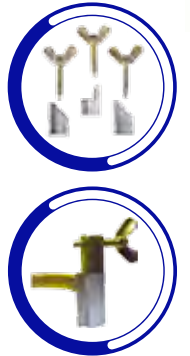

### E-Z Fit Gold Typical Applications

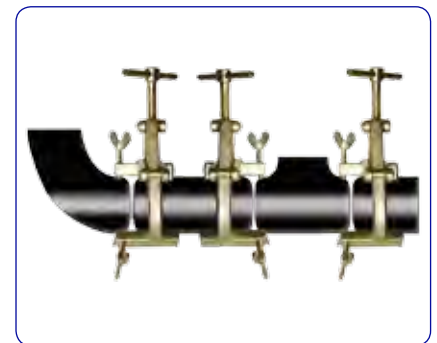
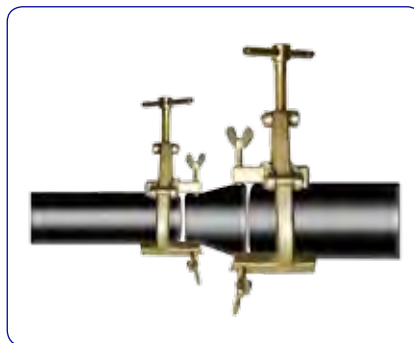

**WARNING:** These E-Z Gold clamps must not be used as a lifting device, as this may result in damage or injury

## Range: 1 - 72"

Our E-Z Fit Pipe Chain Clamps have been designed to offer the welder/pipe fitter the best of both worlds.

A robust pipe clamp with the strength to align and reform, that is also lightweight and easy to operate.

Traditional methods for aligning heavy wall pipe, such as ratchet cable pullers, lugs and bottle jacks are time consuming and inconsistent in the results they achieve, making them unsuitable for the majority of critical alignment applications.

One clamp can fit up a variety of sizes of pipes, elbows, tees, flanges end caps and most other pipe fittings (using the level and support device supplied).

The heavy duty high rise Jackbars and main block provide the strength to reform the pipe either side of the weld gap to eliminate "Hi-Lo", whilst enabling the welder to weld the entire circumference of the pipe with the clamp in situ.

Our chain and screws are zinc passivated, to combat weld spatter and corrosion. All E-Z Chain Clamps are available with stainless steel contact points and chain to enable the welding of exotic materials with no risk of contamination.

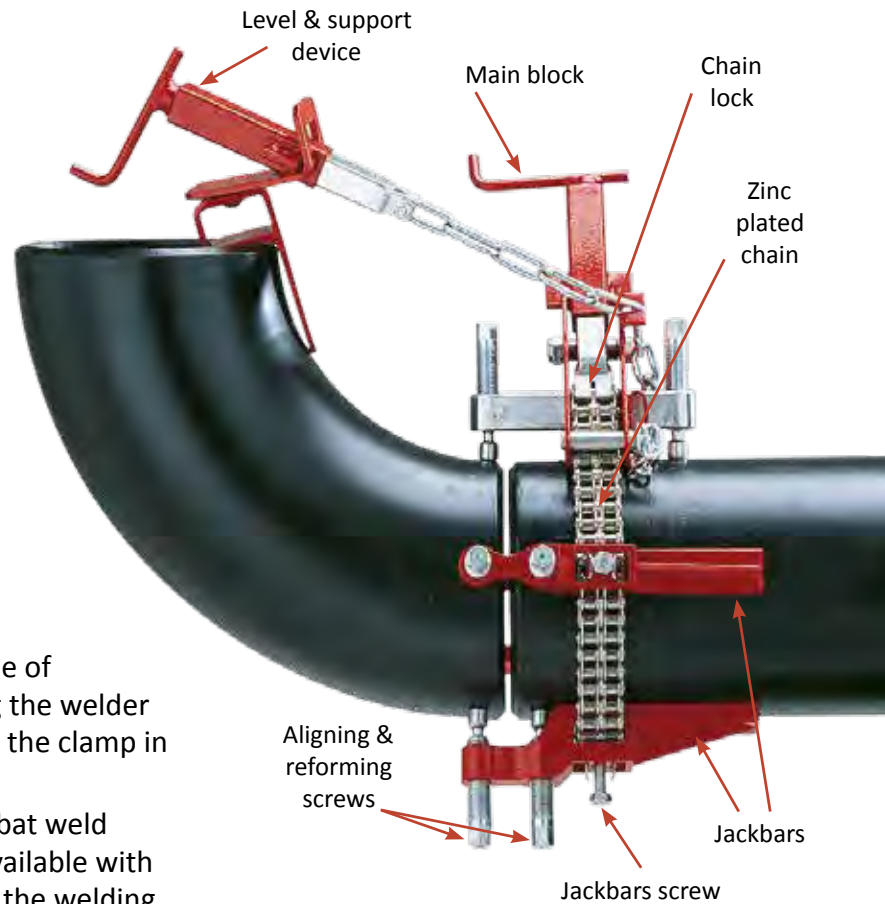

## Features and Advantages:

- **Precision Alignment** - The double jackbars, spaced around the outside diameter of the pipe, provide concise alignment and reforming of the internal or external diameters of both pipes within 0.5mm
- **Extremely Tough** - Reforms pipes on both sides of the weld joint to Schedule 40 pipe and aligns any wall schedule of pipe, elbows, tees and other fittings
- **Adaptable** - The Chain Clamp can be used to align, and reform elbows, tees and other fittings that a cage clamp can not manage. One Chain Clamp covers the range of eight (8) cage clamps
- **High Rise Independent Jackbars** - Double jackscrew 'high rise' jackbars have extra clearance enabling easy access with welding torch/rod. Each Jackscrew has independently pivoting feet to cope with uneven surfaces
- **Safe** - Elbows, tees and other fittings can be held safely and securely in place during alignment with the level and support device





## E-Z Fit Pipe Chain Clamp Versatility

Some examples of fit-ups with the E-Z Fit Pipe Chain Clamp. Each clamp is supplied with all accessories to carry out any fit-up and includes a steel storage box.

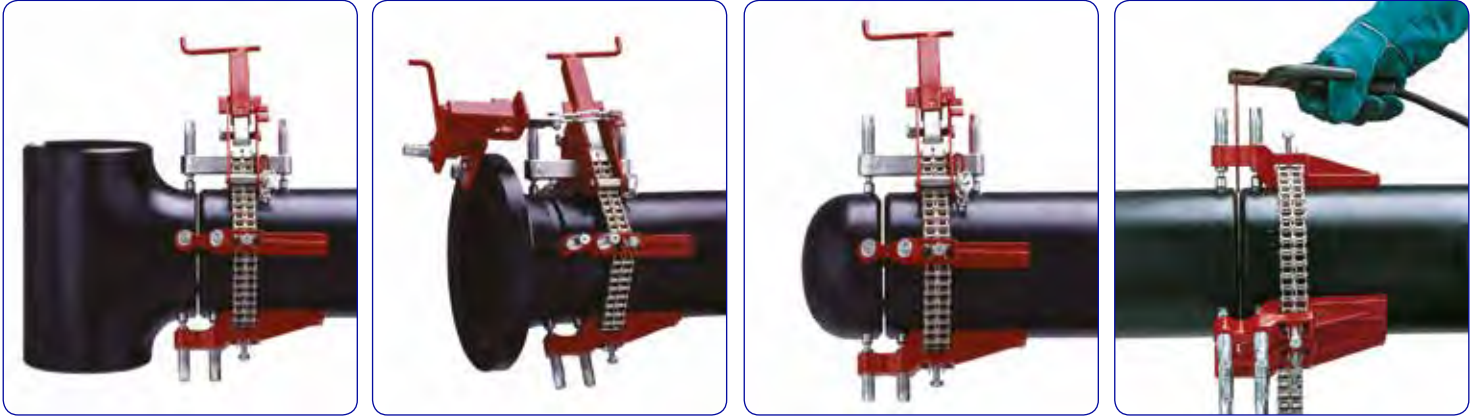

### E-Z Fit Pipe Chain Clamps Include:

- Length of chain required for the pipe range
- Double jackscrew jackbars listed for the pipe range
- Main block
- Fine adjustment
- Level and support device
- Jackscrew wrench
- Parts and operating manual
- Metal storage box
- Come fully assembled ready to use



### Sizes Available

PART NO.	PIPE DIAMETER RANGE (INCH / MM)	NO. OF JACKBARS	REFORMS PIPE TO SCHEDULE	ALIGNS PIPE TO SCHEDULE	SHIPPING WEIGHT (KG / LBS)
EZSCC12	1 - 12" / 25 - 320mm	3	40	80	12kg / 27lbs
EZSCC12SS	1 - 12" / 25 - 320mm	3	40	80	12kg / 27lbs
EZSCC20	4 - 20" / 102 - 500mm	7	40	80	33kg / 72lbs
EZSCC20SS	4 - 20" / 102 - 500mm	7	40	80	33kg / 72lbs
EZSCC36	10 - 36" / 254 - 914mm	8	40	80	67kg / 144lbs
EZSCC36SS	10 - 36" / 254 - 914mm	8	40	80	67kg / 144lbs
EZSCC54	10 - 54" / 254 - 1372mm	13	40	80	82kg / 180lbs
EZSCC54SS	10 - 54" / 254 - 1372mm	13	40	80	82kg / 180lbs
EZSCC72	10 - 72" / 254 - 1829mm	16	40	80	90kg / 199lbs
EZSCC72SS	10 - 72" / 254 - 1829mm	16	40	80	90kg / 199lbs

\* Larger sizes available upon request

## **TAG** E-Z FIT MINI CHAIN CLAMP

*Efficient, quick and easy to use*

The new mini chain clamp is ultra light weight, robust and easy to use comes with 4 Jack bars enabling light duty pipe alignment from 0.5 - 8".



PART NO.	PIPE DIAMETER (INCH / MM)	NO. OF JACKBARS	SHIPPING WEIGHT
EZMCC8	0.5 - 8" / 12 - 210mm	4	1.7kg / 3.8lbs



# E-Z FIT DOUBLE CHAIN CLAMPS

*Ultra heavy duty double chain reforming alignment clamp*

**Range: 10 - 240"**

The E-Z Double Chain Clamp is an extra heavy duty clamp designed for alignment and reforming of pipes and vessels up to 20' (6M) with up to schedule 80 wall thickness. The double chain clamp will align pipes with any wall schedule.

Our specialised triple jackscrew heavy duty jackbars and double chain lock devices can deal with the most difficult of reforming jobs with operational ease.

The extra heavy duty jackbars and double main block provide the strength to accomplish reforming jobs on pipe wall thicknesses that other clamps simply cannot. Models 10 - 36" to 10 - 54" come with level and support device and all other models come with cable hoist.

The E-Z Fit Double Chain Clamps are available as stainless steel models with stainless steel contact points and chain to enable the welding of exotic materials with no risk of contamination. All clamps are supplied in their own durable storage cases.

Clamps can also be supplied with an optional torque wrench to apply the correct tension to the chain (150nm). This allows the exact required tension to be applied to the chain.



## Features and Advantages:

- **Precision Alignment** - The double jackbars, spaced around the outside diameter of the pipe, provide accurate alignment and reforming of the internal or external diameters of both pipes within 0.5mm
- **Extremely Tough** - Reforms pipes on both sides of the weld joint to schedule 80, aligns all wall schedules, elbows, tees and other fittings
- **Adaptable** - The Chain Clamp can be used to align, and reform elbow, tees and other fittings that a cage clamp cannot cope with. One Chain Clamp covers the range of up to 100 cage clamps
- **Extra Heavy Duty Independent Jackbars** - Enable the operator to form the pipe to the required shape. Each Jackbar has three (3) independently pivoting Jackscrews to cope with uneven surfaces
- **Versatile** - Elbows, tees and other fittings can be aligned with the level and support device

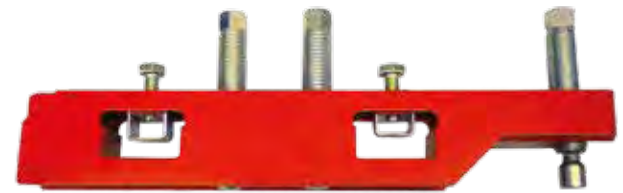

Heavy duty jackbars for arduous aligning and reforming jobs

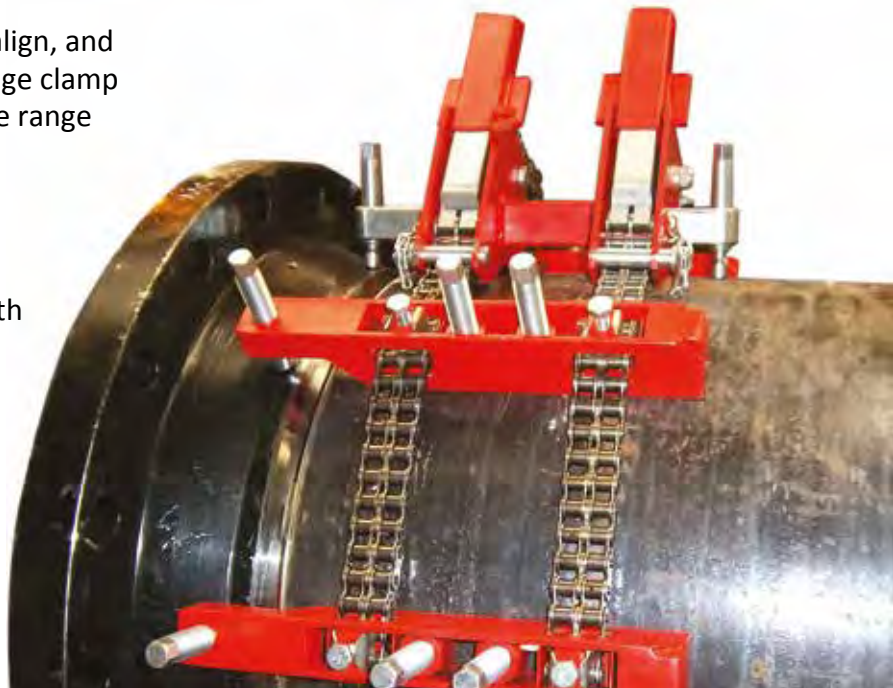

### E-Z Fit Double Chain Clamp includes:

- Length of chain required for the pipe range
- Extra heavy duty jackbars listed for the pipe range
- Number of Main blocks listed for the pipe range
- Two (2) fine adjustments
- Level and support device (larger clamps supplied with cable hoist)
- Jackscrew wrench
- Operating instructions

### Optional:

- Torque wrench
- Carbon or stainless steel spacing screws
- Additional jackbars and Jackscrews
- Additional Chain

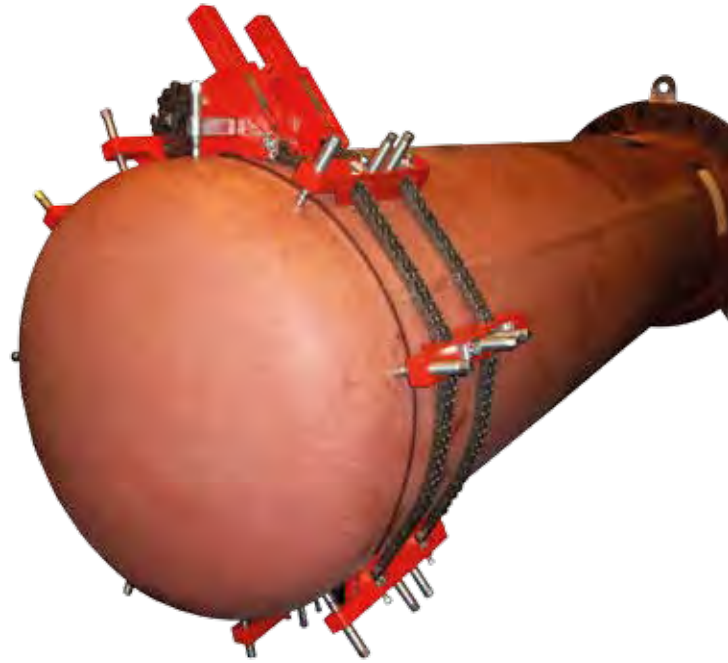

### Sizes Available

PART NO.	PIPE DIAMETER RANGE (INCH / MM)	NUMBER OF JACKBARS	NUMBER OF MAIN BLOCKS	SHIPPING WEIGHT (KG / LBS)
EZDCC10-36	10 - 36" / 254 - 915mm	9	1	100kg / 220lbs
EZDCC10-36 SS	10 - 36" / 254 - 915mm	9	1	100kg / 220lbs
EZDCC10-48	10 - 48" / 254 - 1220mm	12	1	126kg / 278lbs
EZDCC10-48 SS	10 - 48" / 254 - 1220mm	12	1	126kg / 278lbs
EZDCC10-54	10 - 54" / 254 - 1375mm	14	1	136kg / 300lbs
EZDCC10-54 SS	10 - 54" / 254 - 1375mm	14	1	136kg / 300lbs
EZDCC10-60	10 - 60" / 254 - 1525mm	16	1	149kg / 328lbs
EZDCC10-60 SS	10 - 60" / 254 - 1525mm	16	1	149kg / 328lbs
EZDCC10-72	10 - 72" / 254 - 1830mm	20	1	176kg / 387lbs
EZDCC10-72 SS	10 - 72" / 254 - 1830mm	20	1	176kg / 387lbs
EZDCC10-84	10 - 84" / 254 - 2135mm	24	1	200kg / 442lbs
EZDCC10-84 SS	10 - 84" / 254 - 2135mm	24	2	200kg / 442lbs
EZDCC10-96	10 - 96" / 254 - 2440mm	28	2	226kg / 498lbs
EZDCC10-96 SS	10 - 96" / 254 - 2440mm	28	2	226kg / 498lbs
EZDCC10-108	10 - 108" / 254 - 2745mm	32	2	251kg / 554lbs
EZDCC10-108 SS	10 - 108" / 254 - 2745mm	32	2	251kg / 554lbs
EZDCC10-120	10 - 120" / 254 - 3050mm	36	2	277kg / 610lbs
EZDCC10-120 SS	10 - 120" / 254 - 3050mm	36	2	277kg / 610lbs
EZDCC10-132	10 - 132" / 254 - 3355mm	39	2	299kg / 660lbs
EZDCC10-132 SS	10 - 132" / 254 - 3355mm	39	2	299kg / 660lbs
EZDCC10-144	10 - 144" / 254 - 3715mm	42	2	322kg / 710lbs
EZDCC10-144 SS	10 - 144" / 254 - 3715mm	42	2	322kg / 710lbs
EZDCC10-168	10 - 168" / 254 - 4270mm	48	3	367kg / 810lbs
EZDCC10-168 SS	10 - 168" / 254 - 4270mm	48	3	367kg / 810lbs
EZDCC10-192	10 - 192" / 254 - 4880mm	54	3	410kg / 910lbs
EZDCC10-192 SS	10 - 192" / 254 - 4880mm	54	3	410kg / 910lbs
EZDCC10-216	10 - 216" / 254 - 5490mm	60	3	455kg / 1010lbs
EZDCC10-216 SS	10 - 216" / 254 - 5490mm	60	3	455kg / 1010lbs
EZDCC10-240	10 - 240" / 254 - 6100mm	66	3	500kg / 1110lbs
EZDCC10-240 SS	10 - 240" / 254 - 6100mm	66	3	500kg / 1110lbs

\* Larger sizes available upon request



## SPIDER CLAMP - SERIES 400

Popular Model

This model has two independent expanding clamps, allowing independent alignment of two hollow cylindrical components of different diameters. The bottom expanding clamp is inserted and clamped in the pipe by means of the knob. Then the other part (e.g. a flange) is placed over the top expanding clamp and clamped by means of the hand-bar. This model is specially suited for heavy parts. Locating rails are available in stainless steel.

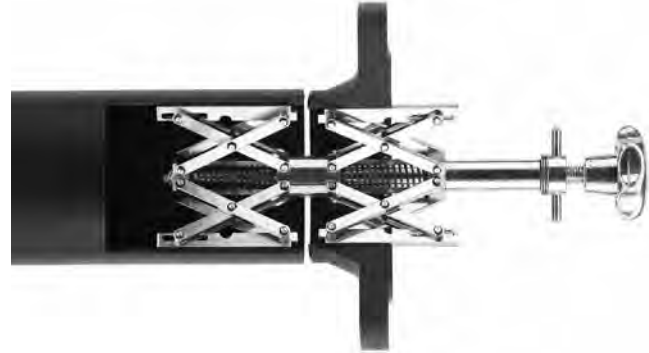

PART NO.	CLAMPING RANGE (MM)	WEIGHT (KG / LBS)
400-1 / 400-1SS*	54 - 140mm	1.25kg / 3lbs
400-2 / 400-2SS*	85 - 220mm	3.6kg / 8lbs
400-3 / 400-3SS*	120 - 350mm	10.5kg / 23lbs
400-4 / 400-4SS*	180 - 520mm	27kg / 60lbs
400-5 / 400-5SS*	400 - 900mm	39kg / 86lbs

\* SS = Stainless Steel

## ELBOW SPIDER CLAMP - SERIES 500

Popular Model

This model with two independent clamps is used for clamping flanges of all kinds and similar parts to elbows and pipe-bends of various diameters. The lower expanding clamp has strong gripping feet which insert into the bend and are tightened by means of the knob. The top expanding clamp is tightened by means of the handbar in the flange.



PART NO.	CLAMPING RANGE(MM)	WEIGHT (KG / LBS)
500-1 / 500-1SS*	54 - 115mm	1kg / 3lbs
500-2 / 500-2SS*	85 - 195mm	3.3kg / 7lbs
500-3 / 500-3SS*	120 - 315mm	9.5kg / 21lbs
500-4 / 500-4SS*	180 - 520mm	23.1kg / 51lbs

\* SS = Stainless Steel

For quick and accurate alignment of pipes of equal or differing diameters on a common centre line. Automatic diameter compensation. There's no need to make additional adjustments. All parts stay easily accessible for welding.



PART NO.	CLAMPING RANGE (MM)	WEIGHT (KG / LBS)
100-1 / 100-1SS*	10 - 70mm	2.1kg / 5lbs
100-2 / 100-2SS*	40 - 140mm	5.9kg / 13lbs
100-3 / 100-3SS*	75 - 330mm	26kg / 57.5lbs

\* SS = Stainless Steel

LINEAR CLAMP - SERIES 200

For quick and accurate alignment and clamping of flanges, nozzles, short pipe sections to pipes and cylindrical tanks. Wedge shaped clamps provide automatic compensation even for parts with greatly differing diameters. Clamps are available in stainless steel.



PART NO.	CLAMPING RANGE (MM)	WEIGHT (KG / LBS)
200-1 / 200-1SS*	15 - 19mm	0.20kg / 0.7lbs
200-2 / 200-2SS*	16 - 20mm	0.20kg / 0.7lbs
200-3 / 200-3SS*	19 - 25mm	0.25kg / 0.9lbs
200-4 / 200-4SS*	24 - 32mm	0.50kg / 1lbs
200-5 / 200-5SS*	31 - 40mm	0.50kg / 1lbs
200-6 / 200-6SS*	38 - 52mm	1.25kg / 3lbs

\* SS = Stainless Steel

SPIDER CLAMP - SERIES 302

For clamping pipes of equal diameter or as a clamp with only one expanding clamping part.

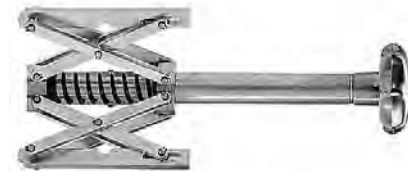

PART NO.	CLAMPING RANGE (MM)	WEIGHT (KG / LBS)
302-1 / 302-1SS*	54 - 140mm	1.1kg / 2lbs
302-2 / 302-2SS*	85 - 220mm	2.5kg / 6lbs
302-3 / 302-3SS*	120 - 350mm	6kg / 13lbs
302-4 / 302-4SS*	180 - 520mm	14kg / 31lbs
302-5 / 302-5SS*	400 - 940mm	20kg / 44lbs

\* SS = Stainless Steel

Cage Clamps are the cost effective method to quickly align a single size of pipe. There are three versions available; manual, ratchet and hydraulic. These are available in two styles, either "Tack" or "No Tack". The tack type has straight cross bars and is removed from the pipe before final welding. The more popular no tack model has arched cross bars to permit a 90% circumferential weld without removing the clamp.

### Manual Cage Clamps Range: 4 - 24"

The TAG Manual Cage Clamps are available in sizes ranging from 4 - 24". The Cage clamp is designed to achieve rapid alignment of two pieces of pipe prior to welding.

- Will not back off while weld is being made
- Simple and easy to use



### Ratchet Cage Clamps Range: 20 - 80"

The TAG Ratchet Type External Line-up Clamp is very strong and accurate, but is also lightweight with standard No-tack arched cross bars.

- Precision Acme Threads ensure great strength and ease of operation
- Will not back off while weld is being made
- Mechanism is enclosed to prevent dirt or mud
- Standard 1" ratchet handle fits all sizes



### Hydraulic Cage Clamps Range: 20 - 80"

Up to 80" external No-tack type line-up clamps, lines up pipe for weld to enable the maximum weld to be made without moving the clamp, hand toggle or powerful hydraulic for accurate alignment.

- Hydraulic jack capacity 5 - 20 ton.
- Specials upon request



## Manual Cage Clamps - Sizes Available

PART NO.	PIPE SIZE RANGE (INCH / MM)	SHIPPING WEIGHT (KG / LBS)
MCC4	4" / 102mm	8.6kg / 19lbs
MCC6	6" / 152mm	14.4kg / 32lbs
MCC8	8" / 203mm	14.9kg / 33lbs
MCC10	10" / 254mm	23kg / 51lbs
MCC12	12" / 305mm	23.9kg / 53lbs
MCC14	14" / 356mm	31.5kg / 70lbs
MCC16	16" / 406mm	45.9kg / 102lbs
MCC18	18" / 457mm	49.5kg / 110lbs
MCC20	20" / 508mm	54kg / 120lbs
MCC24	24" / 610mm	56.7kg / 126lbs

*\* Larger and odd sizes available upon request*

## Ratchet Cage Clamps - Sizes Available

PART NO.	PIPE SIZE RANGE (INCH / MM)	SHIPPING WEIGHT (KG / LBS)
RCC20	20" / 508mm	54kg / 120lbs
RCC24	24" / 610mm	57kg / 126lbs
RCC28	28" / 711mm	67kg / 148lbs
RCC30	30" / 762mm	72kg / 160lbs
RCC32	32" / 813mm	77kg / 170lbs
RCC34	34" / 864mm	82kg / 181lbs
RCC36	36" / 914mm	87kg / 192lbs
RCC40	40" / 1016mm	97kg / 214lbs
RCC42	42" / 1067mm	102kg / 225lbs
RCC48	48" / 1219mm	117kg / 258lbs
RCC54	54" / 1372mm	153kg / 337lbs
RCC60	60" / 1524mm	167kg / 368lbs
RCCH	Ratchet Handle	2.7kg / 6lbs

*\* Larger and odd sizes available upon request*

## Hydraulic Cage Clamps - Sizes Available

PART NO.	PIPE SIZE RANGE (INCH / MM)	SHIPPING WEIGHT (KG / LBS)
HCC20	20" / 508mm	54kg / 120lbs
HCC24	24" / 610mm	57kg / 126lbs
HCC28	28" / 711mm	67kg / 148lbs
HCC30	30" / 762mm	72kg / 160lbs
HCC32	32" / 813mm	77kg / 170lbs
HCC34	34" / 864mm	82kg / 181lbs
HCC36	36" / 914mm	87kg / 192lbs
HCC40	40" / 1016mm	97kg / 214lbs
HCC42	42" / 1067mm	102kg / 225lbs
HCC48	48" / 1219mm	117kg / 258lbs
HCC54	54" / 1372mm	153kg / 337lbs
HCC60	60" / 1524mm	167kg / 368lbs
HCCHJ	Hydraulic Jack	9kg / 20lbs

*\* Larger and odd sizes available upon request*





# RIM CLAMPS

*Ultra heavy duty reforming and alignment clamp*

Designed for aligning and reforming pipes with extreme tensile strengths and capable of handling out of round wall thicknesses up to 51mm.

Jackscrews apply pressure on specific high points to precisely reform and align the pipe or shells, ideal for applications that require critical alignment. Thanks to the moveable jackbars that can be rotated for ease of access, welding and grinding can be completed without releasing clamping pressure to prevent cracking of partially completed welds.

Heavy duty oval-shaped frame, latching mechanism, and jackscrews give the Rim Clamp unrivalled re-forming strength and the capability to handle out of round wall thicknesses up to 51mm. All surfaces of the Rim Clamp that contact the pipe are made of stainless steel, eliminating the risk of contamination when working with exotic materials enabling the Rim clamp to be used in nuclear, water and other similar high purity applications. Sizes 14" and larger feature an automatic locking device to minimise the risk of operator injury.



## Features and Advantages:

- **Extremely accurate** - fit-up on large diameter pipe, shells or vessels
- **Heavy duty** - handles out-of-round conditions up to 2" (51mm)
- **Easy alignment and reforming** - pressure can be applied to high points of the pipe or vessel to reform it to the required shape
- **Versatile** - the clamp can be used for steel or stainless steel applications

## Sizes Available

PART NO.	PIPE DIAMETER RANGE (INCH / MM)	REFORMS PIPE TO SCHEDULE	ALIGNS PIPE TO SCHEDULE	CLAMP WEIGHT (KG / LBS)
RC/12-14	12 - 14" / 305 - 356mm	80	120	54kg / 119lbs
RC/14-16	14 - 16" / 356 - 406mm	80	120	86kg / 190lbs
RC/16-18	16 - 18" / 406 - 457mm	80	120	108kg / 238lbs
RC/14-20	14 - 20" / 356 - 508mm	80	120	126kg / 278lbs
RC/18-24	18 - 24" / 457 - 610mm	80	120	158kg / 348lbs
RC/20-26	20 - 26" / 610 - 660mm	80	120	162kg / 357lbs
RC/22-28	22 - 28" / 559 - 711mm	80	120	171kg / 377lbs
RC/26-32	26 - 32" / 660 - 813mm	80	120	180kg / 397lbs
RC/30-36	30 - 36" / 762 - 914mm	80	120	189kg / 417lbs
RC/34-40	34 - 40" / 864 - 1016mm	80	120	203kg / 447lbs
RC/38-44	38 - 44" / 965 - 1118mm	80	120	221kg / 487lbs
RC/42-48	42 - 48" / 1069 - 1219mm	80	120	230kg / 507lbs
RC/44-50	44 - 50" / 1118 - 1270mm	80	120	275kg / 606lbs
RC/46-52	46 - 52" / 1168 - 1321mm	80	120	295kg / 649lbs
RC/54-60	54 - 60" / 1372 - 1524mm	80	120	338kg / 745lbs

*\* Smaller and Larger sizes available upon request*





PIPE EQUIPMENT SPECIALISTS LTD

## PIPE STANDS & ROLLERS



TAG Pipe Equipment Specialists manufactures pipe stands that have been designed to give you the highest quality at the best price.

TAG Tri Stands are constructed from box section and are available with a variety of different head styles to suit any application.

## Features and Advantages

- 1½" Square box section construction
- 1,585kg / 3,500lbs load capacity
- Choice of fixed leg base or folding leg base
- Folding legs allow for easy storage and transportation
- Comprehensive range of 9 different head styles
- Adjustable in height from 27 - 48" (71 - 122cm)
- Independently load tested
- CE Conformity Certified with CE Mark



TPS300 - Tri Fixed Stand fitted with: TVH300 Standard V-Head



TPS300 - Tri Fixed Stand fitted with: TVH300L Large V-Head



TFS301 - Tri folding stand shown open and closed

## Tri Fixed Stand (base only)



PART NO.	LOAD CAPACITY (KG / LBS)	WEIGHT (KG / LBS)	PIPE SIZE
TPS300	1,585kg / 3,500lbs	7.6kg / 17lbs	1 - 24"

## Tri Folding Stand (base only)



PART NO.	LOAD CAPACITY (KG / LBS)	WEIGHT (KG / LBS)	PIPE SIZE
TFS301	1,585kg / 3,500lbs	7.6kg / 17lbs	1 - 24"

## Tri V-Head



PART NO.	LOAD CAPACITY (KG / LBS)	WEIGHT (KG / LBS)	PIPE SIZE
TVH300	1,585kg / 3,500lbs	3.4kg / 7lbs	Up to 12"

## Large V-Head (see page 23 for Head options)



PART NO.	LOAD CAPACITY (KG / LBS)	WEIGHT (KG / LBS)	PIPE SIZE
TVH300L	1,585kg / 3,500lbs	7.6kg / 17lbs	Up to 24"

## Steel Wheel Heads (slip on style)



PART NO.	LOAD CAPACITY (KG / LBS)	WEIGHT (KG / LBS)	PIPE SIZE
SWH300	450kg / 990lbs	3.4kg / 7lbs	1 - 12"
* SWH300SS	450kg / 990lbs	3.4kg / 7lbs	1 - 12"

## Steel Wheel Head



PART NO.	LOAD CAPACITY (KG / LBS)	WEIGHT (KG / LBS)	PIPE SIZE
SWH350	1,000kg / 2,205lbs	4.9kg / 11lbs	1 - 24"
* SWH350SS	1,000kg / 2,205lbs	4.9kg / 11lbs	1 - 24"

## Nylon Wheel Heads (slip on style)



PART NO.	LOAD CAPACITY (KG / LBS)	WEIGHT (KG / LBS)	PIPE SIZE
* NWH300	450kg / 992lbs	2kg / 5lbs	1 - 12"

## Nylon Wheel Head



PART NO.	LOAD CAPACITY (KG / LBS)	WEIGHT (KG / LBS)	PIPE SIZE
* NWH350	450kg / 990lbs	3.3kg / 7lbs	1 - 24"

## Ball Transfer Heads (slip on style)



PART NO.	LOAD CAPACITY (KG / LBS)	WEIGHT (KG / LBS)	PIPE SIZE
BTH300	450kg / 990lbs	2.5kg / 6lbs	1 - 12"
* BTH300SS	450kg / 990lbs	2.5kg / 6lbs	1 - 12"

## Roller/Pipe Bar Heads



PART NO.	LOAD CAPACITY (KG / LBS)	WEIGHT (KG / LBS)	PIPE SIZE
RBH300	1,000kg / 2,205lbs	4.25kg / 9lbs	n/a
PBH300	1,000kg / 2,205lbs	4.25kg / 9lbs	Up to 12"

## Pipe Chain Vice Head



PART NO.	LOAD CAPACITY (KG / LBS)	WEIGHT (KG / LBS)	PIPE SIZE
PCV300	1000kg / 2205lbs	6.5kg / 14.3lbs	0.5 - 6"

## Stainless Steel Head (slip on style)

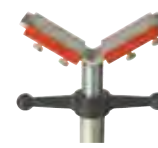

PART NO.	LOAD CAPACITY (KG / LBS)	WEIGHT (KG / LBS)	PIPE SIZE
* SSH300	1,585kg / 3,500lbs	1.0kg / 2lbs	1 - 12"

# TAG DUO STANDS

Heavy duty four leg height adjustable, pin lock pipe stands

The Duo is height adjustable and uses quick change style heads. Designed for large diameter pipe rotation and feeding. With locking brakes on the wheels to secure the load for marking, layout or fit-up.

Now supplied with folding legs as standard for ease of use and transport and ultra safe pin locking design.

## Features and Advantages

- Load capacity 2,400kg / 5,290lbs
- Folding legs for ease of transport and storage
- Self centering head adjustment from either side
- Height adjustable 29 - 42.5" (74.5 - 108cm)
- 2 - 48" (51 - 1219 mm) pipe diameter capacity
- Quick height adjustment with additional fine thread for workpiece levelling
- 'Trued' wheels eliminate 'corkscrewing' of pipe during rotation
- Lockable wheels to hold pipe in position
- Safety pins to lock stand at working height
- CE Conformity Certified with CE Mark

The Duo Stand utilises the fine adjustment thread. This allows precise adjustment of the working height and can compensate for uneven surfaces to ensure pipe is level at all times.

The unique safety locking pins allow the Duo Stand to be fixed at the various working heights.

Final adjustment and leveling can then be made with the fine adjustment handle.



NEW  
IMPROVED  
PIN LOCK  
DESIGN



Max 108cm / 42.5"  
Min 74.5cm / 29"



# TAG DUO STAND OPTIONS

The Quick Change style heads increase the versatility of the duo stand.

The heads can be changed in a matter of seconds, without tools, to adapt to almost any applications.

Roller wheels are available in steel, stainless steel or nylon. Ball transfer heads are available in steel or stainless steel.



## Simple Head Changeover



1. Lift quick release tab



2. Slide forward and remove



Various height holes enable the operator to fix the stand at the required working height using the safety locking pins

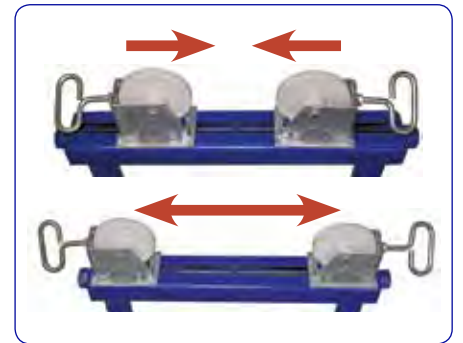

Self centering adjustable heads from 2 - 48" pipe

### Base Unit Only



PART NO.	LOAD CAPACITY (KG / LBS)	WEIGHT (KG / LBS)
DPS200	2,400kg / 5,290lbs	19.5kg / 43lbs

### Pair Nylon Wheel Heads



PART NO.	LOAD CAPACITY (KG / LBS)	WEIGHT (KG / LBS)
* NWH200	450kg / 990lbs	2.2kg / 5lbs

### Pair Ball Transfer Heads



PART NO.	LOAD CAPACITY (KG / LBS)	WEIGHT (KG / LBS)
BTH200	1,450kg / 3,197lbs	3kg / 6lbs
* BTH200SS	1,450kg / 3,197lbs	3kg / 6lbs

### Pair Steel Wheel Heads



PART NO.	LOAD CAPACITY (KG / LBS)	WEIGHT (KG / LBS)
SWH200	2,400kg / 5,290lbs	3kg / 6lbs
* SWH200SS	2,400kg / 5,290lbs	3kg / 6lbs

\* Suitable for Stainless Steel



# QUATTRO STANDS

Heavy duty pipe stands for large diameter and heavy wall pipe

The Quattro Heavy Duty Pipe Stands are the ideal solution for heavy duty pipe handling, in the workshop or for site applications.

The Large V-Head, heavy duty base and variety of head options make the Quattro the most durable and versatile pipe stand on the market.

The Quattro stand can be used as a simple jack stand, supplied as standard with levelling pads to accommodate uneven working surfaces. Weight load tested to 2,265kg / 5,000lbs per stand.

The Quattro stands can also be supplied with lockable 8" castor wheels so pipes of up to 36" diameter and any length can be moved around a workshop or site, without the need for a crane or forklift.

## Features and Advantages

- Load capacity 2,265kg / 5,000lbs
- Variety of head options available
- Optional castor wheels for pipe transportation
- Height adjustable
- Heavy duty box section construction
- CE Conformity Certified with CE Mark



Max 112cm / 44"  
Min 82cm / 32"

QVH400 Large V-Head shown with SWH400 steel wheels fitted

Shown with RWK400 roller wheel kit fitted



Max 92cm / 36"  
Min 61cm / 24"



Levelling pads supplied as standard

Transport pipe around the site or workshop with ease



## Base Unit (complete with levelling pads)



PART NO.	LOAD CAPACITY (KG / LBS)	WEIGHT (KG / LBS)	PIPE SIZE
QPS400	2,265kg / 5,000lbs	10kg / 22lbs	n/a

## Large V-Head



PART NO.	LOAD CAPACITY (KG / LBS)	WEIGHT (KG / LBS)	PIPE SIZE
QVH400	2,265kg / 5,000lbs	8.5kg / 19lbs	1 - 36"

## Steel and Stainless Steel Wheels

These four-wheel kits can be fitted into the QVH400 large V-Head to enable pipe to be rotated. Steel and stainless steel wheels are available to suit all applications.



PART NO.	LOAD CAPACITY (KG / LBS)	WEIGHT (KG / LBS)	PIPE SIZE
SWH400	1,200kg / 2,645lbs	4kg / 8lbs	1 - 36"
* SWH400/SS	1,200kg / 2,645lbs	4kg / 8lbs	1 - 36"

## Ball Transfer Head

Consists of two 1½" roller balls which can be mounted in V-Head slots for a range of up to 36" (915mm) pipe.



PART NO.	LOAD CAPACITY (KG / LBS)	WEIGHT (KG / LBS)	PIPE SIZE
BTH400	1,200kg / 2,645lbs	2.3kg / 5lbs	1 - 36"
* BTH400/SS	1,200kg / 2,645lbs	2.3kg / 5lbs	1 - 36"

## Nylon Wheel

The kit consists of four nylon wheels that can be mounted into the QVH400 Large V-Head, to enable the Quattro Stand to be used with stainless steel without the risk of marking the pipe.



PART NO.	LOAD CAPACITY (KG / LBS)	WEIGHT (KG / LBS)	PIPE SIZE
* NWH400	450kg / 990lbs	1.8kg / 4lbs	1 - 36"

## Stainless Steel Sleeves

When working with stainless steel pipe, the sleeve option instantly converts the Quattro Stand into a speciality tool for stainless steel welding, preventing carbon contamination.



PART NO.	LOAD CAPACITY (KG / LBS)	WEIGHT (KG / LBS)	PIPE SIZE
* SSS400	2,265kg / 5,000lbs	1kg / 2lbs	1 - 36"

## Hold Down Device

The Hold-Down Device uses high tensile strength for gripping pipe onto the large V-Head when either welding or using the Quattro stand for pipe transportation. Chain extension kits available for pipe up to 36" (101cm). Standard upto 18".



PART NO.	LOAD CAPACITY (KG / LBS)	WEIGHT (KG / LBS)	PIPE SIZE
HDD400	n/a	7kg / 16lbs	1 - 36"

## Roller Wheel Kit

Four 8" (20cm) heavy duty wheels make up the Quattro Stand Roller Wheel Kit. The wheels have a quick action brake system.

*Weight load capacity dependant on head style*



PART NO.	LOAD CAPACITY (KG / LBS)	WEIGHT (KG / LBS)	PIPE SIZE
RWK400	1,225kg / 2,700lbs	11kg / 24lbs	n/a

# TAG UNO STANDS

*Specialist Pipe Stands for low level and tight access*



The UNO Stand is a basic single tubed pipe stand, simple to use and easy to set-up. Popular for tight access jobs in power stations, submarines, refinery's etc. A favourite for low level work in all fab shops. Available in 4 standard heights. Optional roller heads from the Tri Stand series (page 19) can also be fitted to the V-Head of the UNO Stand to suit varying applications.

Please see page 19 for all Head options



Steel Wheel Head



Nylon Wheel Head



Ball Transfer Head



Roller Bar Head



Uno with Castor Wheels

PART NO.	MIN/MAX HEIGHT (MM / INCH)	LOAD CAPACITY (KG / LBS)	PIPE SIZE
UPS01	175 - 300mm / 7 - 12"	450kg / 1000lbs	Up to 12"
UPS02	300 - 425mm / 12 - 17"	450kg / 1000lbs	Up to 12"
UPS03	425 - 550mm / 17 - 22"	450kg / 1000lbs	Up to 12"
UPS04	550 - 675mm / 22 - 27"	450kg / 1000lbs	Up to 12"

*We can manufacture to any height with 125mm / 5" range*

# TAG TRI CHAIN VICE STAND

*A simple but effective solution to small bore pipe handling*

**Optimised Base For More Working Area** - Benders are located at the rear of the base and three tool hangers are provided

**Integrated Ground Lug** - Provides a conductive surface to connect the earth cable

**Self Hooking for 4" Pipe** - No need to use a second hand to engage the chain into the wear plate

**Leg Chain** - Retains legs even when subjected to rugged use during operation and transport

**Rugged Tool Tray** - Prolonged stability before requiring a leg adjustment



TCVS6

PCV6

PART NO.	DESCRIPTION	PIPE SIZE	WEIGHT (KG / LBS )	WORKING HEIGHT (CM / INCH)
TCVS6	Tri Chain Vice Stand	0.5 - 6"	21kg / 46lbs	91cm / 36"
PCV6	Pipe Chain Vice Clamp	0.5 - 6"	5kg / 11lbs	n/a

*Stainless Steel Jaws and Chain Kit available*



# TAG MEGA PIPE STANDS

*Heavy duty stand that can withstand the toughest pipe fabrication abuse*

The TAG Mega Pipe Stands fit nicely between the more common Pipe Jack and Pipe Stand lines and the much heavier duty Turning Roll products that are available on the market today.

The Mega Pipe Stands safely holds larger diameter heavy wall pipe off the ground at an ergonomic height, while allowing the slight height adjustment for fit ups via the twin 1¾ solid acme rods.

Extra features like four way forklift capabilities or optional v groove wheels allow the durable Mega Pipe Stands to be moved with ease within heavy duty pipe fabrication facilities.

If you have a heavy wall fabrication project up to 60 inches, the Mega Pipe Stands are your answer.

## TAG MEGA PIPE STAND 3 TON



PART NO.	DESCRIPTION	LOAD CAPACITY (KG / LBS)	PIPE SIZE	MIN/MAX HEIGHT (CM / INCH)	WEIGHT (KG / LBS)
MPS3000	3 Ton Mega Pipe Stand with Urathane wheels	3000kg / 6600lbs	4 - 48"	86 - 122cm / 38 - 48"	54kg / 118lbs

## TAG MEGA PIPE STAND 5 TON



PART NO.	DESCRIPTION	LOAD CAPACITY (KG / LBS)	PIPE SIZE	MIN/MAX HEIGHT (CM / INCH)	WEIGHT (KG / LBS)
MPS5000	5 Ton Mega Pipe Stand with Urathane wheels	5000kg / 1100lbs	4 - 60"	63.5 - 89cm / 25 - 35"	120kg / 263lbs

# **TAG** MEGA PIPE STAND 8 TON



PART NO.	DESCRIPTION	LOAD CAPACITY (KG / LBS)	PIPE SIZE	MIN/MAX HEIGHT (CM / INCH)	WEIGHT (KG / LBS)
MPS8000	8 Ton Mega Pipe Stand with Urathane wheels	8000kg / 17600lbs	4 - 60"	63.5 - 89cm / 25 - 35"	157kg / 345lbs

# **TAG** MEGA PIPE BLOCK



PART NO.	DESCRIPTION	LOAD CAPACITY (KG / LBS)	PIPE SIZE	MIN/MAX HEIGHT (CM / INCH)	WEIGHT (KG / LBS)
MPB10000	Mega Pipe Block	10000kg / 22000lbs	2 - 72"	15cm Fixed / 6" Fixed	119kg / 261lbs

# TAG HIGH PIPE STAND

*Easy and safe for high pipe working applications*

The TAG Pipe 6ft folding jack allows a pipe fabricator to hold pipe in a safe position up to 6ft tall.

The folding base design with handle allows easy transport into tight spaces and the bottom T-handle locks the jack open while minimising stand wobble.

The 6 foot jack is ideal in any location where increased height pipe fit ups are necessary but can also be used in normal height conditions when adjusted in a lower height position.

## Features and Advantages

- Height adjustment from 39 - 72" (99 - 180cm) tall
- 450kg / 1,000lbs weight capacity
- Increased width of stance increases stability
- Convenient carry handle for transport into and around work sites
- Lock washer can be fastened to base for safety
- Folding design allows easy transport and convenient storage

PART NO.	LOAD CAPACITY (KG / LBS)	PIPE SIZE
HPS600	450kg / 1000lbs	Up to 12"

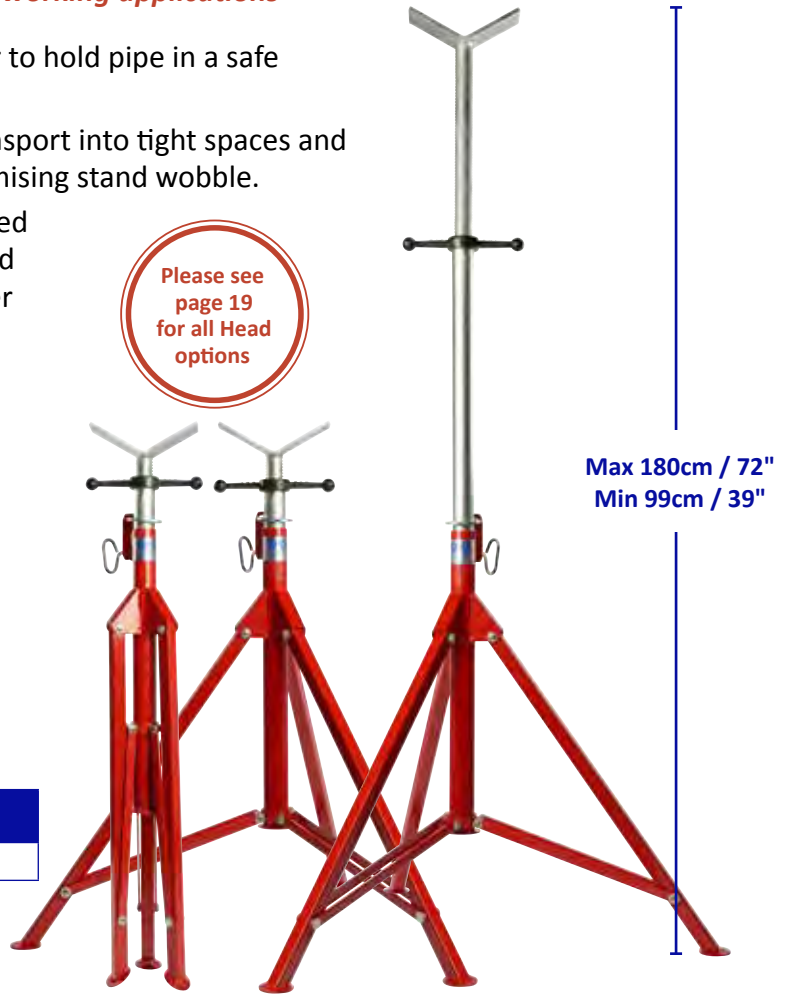

# TAG PIPE CART

*The easy way to move and store pieces or bundles of pipe*

## Features and Advantages

- Transports up to 8m / 24ft lengths
- 2,200lbs / 1000kg capacity
- Carries up to 36" pipe, squares, bundles, and more
- Designed for paved shop floors
- Shipping weight 80kg / 175lbs



PART NO.	DESCRIPTION	LOAD CAPACITY (KG / LBS)	PIPE SIZE
PC1	Pipe Cart	1000kg / 2200lbs	Up to 36"

# TAG PIPE BUGGY

*The safe and easy way to move pipe around the job site*

The Pipe Buggy offers a safe method of handling and moving pipes around the workshop or site easily, avoiding damage to the pipe as a result of it being dragged along the ground. At only 31.8kg / 70lbs it is a light weight yet robust solution to pipe handling problems.

With its innovative handle and ratchet strap it allows the operator to lift the pipe from the floor onto the buggy with minimal effort.

**Max Pipe diameter:** 12"

**Max Pipe length:** 6.1m

**Max Pipe weight:** 450kg / 990lbs

## Features and Advantages

- Flat free tyres
- Ratchet hold down strap to secure pipe
- Quick disconnecting handle for easy storage



## Lift easily in 3 simple steps

- 1** Secure Buggy to pipe in the upside down position using the strap supplied.



- 2** Use handle for leverage to flip Buggy & pipe.



- 3** Reposition handle to walk with pipe.



PART NO.	DESCRIPTION	HEIGHT		WIDTH		WIDTH BETWEEN WHEELS		LENGTH		WEIGHT	
		INCH	CM	INCH	CM	INCH	CM	INCH	CM	KG	LBS
PB1	Pipe Buggy	21	53	28	71	16	41	28	71	31.8	70

# TAG PIPE DOLLY

*The TAG Biggy Buggy*

TAG Pipe's Pipe Dolly is used in many field operations allowing the transportation of pipe without the need for a gas or electric powered lift.

## Features and Advantages

- Transports pipe up to 24ft
- 2,200lbs / 1000kg capacity
- Carries up to 20" pipe, fittings, boxes, and more
- Sold with flat free tyres as standard
- Shipping weight 80kg / 175lbs with some assembly required



PART NO.	LOAD CAPACITY (KG / LBS)	PIPE SIZE
PD1	1000kg / 2200lbs	20" / 500mm

# TAG PIPE CRADLES & SLINGS

TAG Pipe Cradles and Slings are an effective way to move pipe, specifically designed for pipeline installation projects. TAG currently offers cradles from 2 - 24" and all are equipped with 4 inch urethane "round cut" wheels with sealed anti-friction bearings. All spreader bar designs are third party tested and comply with industry standards. These models are equipped with 5/8 wire rope and all rope is swaged and certified at a wire rope rigging company partnered with TAG.

## Features and Advantages

- Durable 90a urethane coating designed for multiple uses
- Sealed anti-friction bearings
- Measures 4" tread width x 4.5" diameter
- Designed for use with 5/8 wire rope
- Machined hub for smooth wheel rotation

PART NO.	DESCRIPTION	LOAD CAPACITY (KG / LBS)
T2001	Roller Sling 2 - 8"	1,300kg / 3,000lbs
T2002	2 Strand Roller Cradle 6 - 12"	7,710kg / 17,000lbs
T2003	2 Strand Roller Cradle 12 - 24"	7,710kg / 17,000lbs
T2004	4 Strand Roller Cradle 12 - 24"	12,700kg / 28,000lbs



T2001



T2002



T2003



T2004

# TAG ROLLER STANDS

*Light duty low level roller stands for pipe feeding*

## Features and Advantages

- Extremely easy pipe feeding
- Free standing or In-trench options
- Differing trench widths accommodated
- Multi positional
- Rubber coated rollers minimise pipe damage
- Three sizes available to suit pipes from 63 - 1200mm (2 - 48")



PRS3



PRS1

PART NO.	PIPE DIAMETER RANGE (MM / INCH)	LOAD CAPACITY (KG / LBS)	WEIGHT (KG / LBS)
PRS1	63 - 355mm / 2 - 14"	200kg / 440lbs	5kg / 11lbs
PRS2	250 - 630mm / 10 - 24"	1000kg / 2200lbs	12kg / 27lbs
PRS3	500 - 1200mm / 20 - 48"	1000kg / 2200lbs	13kg / 29lbs
PRT1	63 - 355mm / 2 - 14"	200kg / 440lbs	6kg / 13lbs



PRT1 - Pipe Roller for trenches

# TAG ROLLER STANDS

*Floor or Bench mountable pipe trestles*

These heavy duty stands are designed to be either floor or bench mounted. Available with 4 head adjustable styles to suit pipes from 4 - 48".



PART NO.	HEAD STYLE	LOAD CAPACITY (KG / LBS)	WEIGHT (KG / LBS)
RPS500	Base unit only	2,400kg / 5,290lbs	5.8kg / 13lbs
SWH500	Pair steel wheel heads	2,400kg / 5,290lbs	3.5kg / 8lbs
* SWH500SS	Pair stainless steel wheel heads	2,400kg / 5,290lbs	3.5kg / 8lbs
* NWH500	Pair nylon wheel heads	450kg / 990lbs	2.2kg / 5lbs
BTH500	Pair ball transfer heads	1,450kg / 3,197lbs	3.5kg / 8lbs
* BTH500SS	Pair stainless steel ball transfer heads	1,450kg / 3,197lbs	3.5kg / 8lbs
S/FTR500	Pair steel feed through roller	2,400kg / 5,290lbs	3.5kg / 8lbs
* SS/FTR500	Pair stainless steel feed through roller	2,400kg / 5,290lbs	3.5kg / 8lbs
* N/FTR500	Pair nylon feed through roller head	450kg / 990lbs	3.0kg / 7lbs

\* Suitable for Stainless Steel

# TAG QUICK CHANGE ROLLERS

*Rapid, self centering pipe trestles*



Self Centering heads for rapid adjustment to suit pipe diameter

All heads are 'Quick Change' style  
Fully adjustable heads from 1 - 48" pipe. With brakes to lock loads for fit-up

PART NO.	HEAD STYLE	LOAD CAPACITY (KG / LBS)	WEIGHT (KG / LBS)
QCR501	Base unit only	2,400kg / 5,290lbs	5.9kg / 13lbs
SWH200	Pair steel wheel heads	2,400kg / 5,290lbs	3.8kg / 8lbs
* SWH200SS	Pair stainless steel wheel heads	2,400kg / 5,290lbs	3.8kg / 8lbs
* NWH200	Pair nylon wheel heads	450kg / 990lbs	2.2kg / 5lbs
BTH200	Pair ball transfer heads	1,450kg / 3,197lbs	3kg / 7lbs
* BTH200SS	Pair stainless steel ball transfer heads	1,450kg / 3,197lbs	3kg / 7lbs

\* Suitable for Stainless Steel

# TAG PIPE RACK ROLLERS

Heavy Duty Beam Clamp Rigging Rollers

TAG Pipe Rack Rollers are used for a variety of Industries and applications, typically for installation of pipes into racks at Refineries, Power Stations and other Industrial Plants.

All the TAG Pipe Rack Rollers are designed to be lightweight, with I Beam clamps for quick installation and various roller head options so that all sizes and weights of pipe can be easily, safely and efficiently installed.

## Features & Advantages

- Six configurations from 1 - 10 tons capacity
- Three sizes for 2" - 60" pipe diameters
- Urethane wheels with sealed bearings
- Easy to replace wheels, bolt off and on in seconds
- Comes ready to use on Stainless Steel
- Convenient and safe carry handles on all models
- Safety Leash included with all models

2" - 24"



T2110

4" - 48"



T2125

16" - 60"



T2135



T2110HD



T2125HD



T2135HD

PART NO.	T2110	T2110HD	T2125	T2125HD	T2135	T2135HD
<b>Load Capacity</b>	<b>1 Ton</b> 1,016kg 2,240lbs	<b>3 Tons</b> 3,048kg 6,720lbs	<b>5 Tons</b> 5,080kg 11,200lbs	<b>10 Tons</b> 10,160kg 22,400lbs	<b>5 Tons</b> 5,080kg 11,200lbs	<b>10 Tons</b> 10,160kg 22,400lbs
<b>Pipe Diameter Range</b>	<b>2" - 24"</b> 50 - 610mm	<b>2" - 24"</b> 50 - 610mm	<b>4" - 48"</b> 100 - 1220mm	<b>4" - 48"</b> 100 - 1220mm	<b>16" - 60"</b> 400 - 1530mm	<b>16" - 60"</b> 400 - 1530mm
<b>Complete Unit Weight</b>	27kg 59lbs	43kg 95lbs	59kg 130lbs	82kg 180lbs	66kg 145lbs	91kg 200lbs
<b>Footprint L x W x H</b>	16.5" x 20.5" x 8" 41.9 x 52 x 20.3cm	16.5" x 20.5" x 8" 41.9 x 52 x 20.3cm	19" x 30" x 8.75" 48.3 x 76.2 x 22.2cm	19" x 30" x 8.75" 48.3 x 76.2 x 22.2cm	21" x 34" x 8.75" 53.3 x 86.4 x 22.2cm	21" x 34" x 8.75" 53.3 x 86.4 x 22.2cm
<b>Beam Flange Width Range</b>	6" - 12" 150 x 300mm	6" - 12" 150 x 300mm	6" - 12" 150 x 300mm	6" - 12" 150 x 300mm	6" - 12" 150 x 300mm	6" - 12" 150 x 300mm

Roller Maintains at Center of I Beam

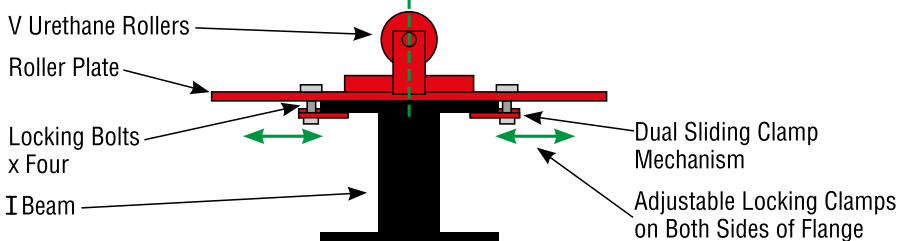

# TAG PIPE LAUNCHERS

Heavy Duty Pipe Launchers

TAG Pipe Launchers are used for a variety of Industries and applications, typically for installation of pipes into Pipe Lines, Trenches, Racks at Refineries, Power Stations and other Industrial Plants.

## Features & Advantages

- Six configurations from 1 - 10 tons capacity
- Three sizes for 2" - 60" pipe diameters
- Urethane wheels with sealed bearings
- Easy to replace wheels, bolt off and on in seconds
- Comes ready to use on Stainless Steel
- Convenient and safe carry handles on all models



2" - 24"

T2115



4" - 48"

T2126



16" - 60"

T2136



T2115HD



T2126HD



T2136HD

PART NO.	T2115	T2115HD	T2126	T2126HD	T2136	T2136HD
Load Capacity	1 Ton 1,016kg 2,240lbs	3 Tons 3,048kg 6,720lbs	5 Tons 5,080kg 11,200lbs	10 Tons 10,160kg 22,400lbs	5 Tons 5,080kg 11,200lbs	10 Tons 10,160kg 22,400lbs
Pipe Diameter Range	2" - 24" 50 - 610mm	2" - 24" 50 - 610mm	4" - 48" 100 - 1220mm	4" - 48" 100 - 1220mm	16" - 60" 400 - 1530mm	16" - 60" 400 - 1530mm
Complete Unit Weight	41kg 89lbs	57kg 105lbs	74kg 162lbs	97kg 213lbs	81kg 178lbs	104kg 229lbs

## TAG 1 TON PIPE ROTATOR

Speed adjustable, pedal operated, floor/bench rotator

Our 1 ton rotator set (1 drive unit + 1 idler) with foot pedal control and fine speed adjustment, is proving to be most popular in fabrication workshops across the globe!

- Additional idler units available to accommodate longer pipe lengths
- Larger & heavier duty units also available



PART NO.	WHEEL DIMENSION (MM / INCH)	MAX DRIVE CAPACITY (KG / LBS)	TURNING CAPACITY (MM / INCH)	WHEEL LINEAR SPEED	POWER
T1TPR	250mm / 10"	1000kg / 2200lbs	115 - 500mm / 4 - 20"	0.2 - 2min	110v / 220v

\* Suitable for Stainless Steel





PIPE EQUIPMENT SPECIALISTS LTD

## PIPE PURGING EQUIPMENT

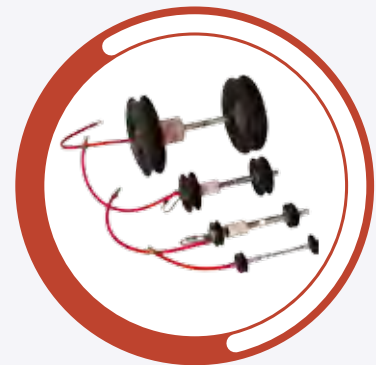



## PIPE EQUIPMENT SPECIALISTS LTD

### WHY PURGE?

When welding stainless steel, titanium and other corrosion resistant materials, the perfect environment for welding is paramount to maintaining the corrosion resistant properties. During the welding process, the weld seam is subjected to heat and air which causes oxidation, if the correct processes are not adhered to. For the best results, oxidation must be prevented. The quality of the exotic corrosion resistant material welding is dependent on the correct purging methods to minimise or eliminate oxidation.



Argon Purge 12ppm  
Vol. O<sup>2</sup> Content



Argon Purge 60ppm  
Vol. O<sup>2</sup> Content



Argon Purge 70ppm  
Vol. O<sup>2</sup> Content



Argon Purge 200ppm  
Vol. O<sup>2</sup> Content

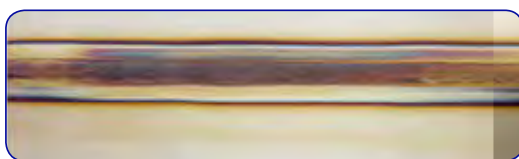

Argon Purge 250ppm  
Vol. O<sup>2</sup> Content



Argon Purge 500ppm  
Vol. O<sup>2</sup> Content

#### Weld Quality

The effective welding of stainless steel, titanium and other exotic materials for the nuclear, petrochemical, pharmaceutical, semi-conductor, aerospace and food industries requires the proper tools to create a perfect weld environment. Purging equipment and its use has a major impact on preventing oxidation and improving final weld quality. The basic principles of purging can be seen below. TAG supply a comprehensive range of systems to create the correct welding environment, whatever the application.

## Principles of Purging

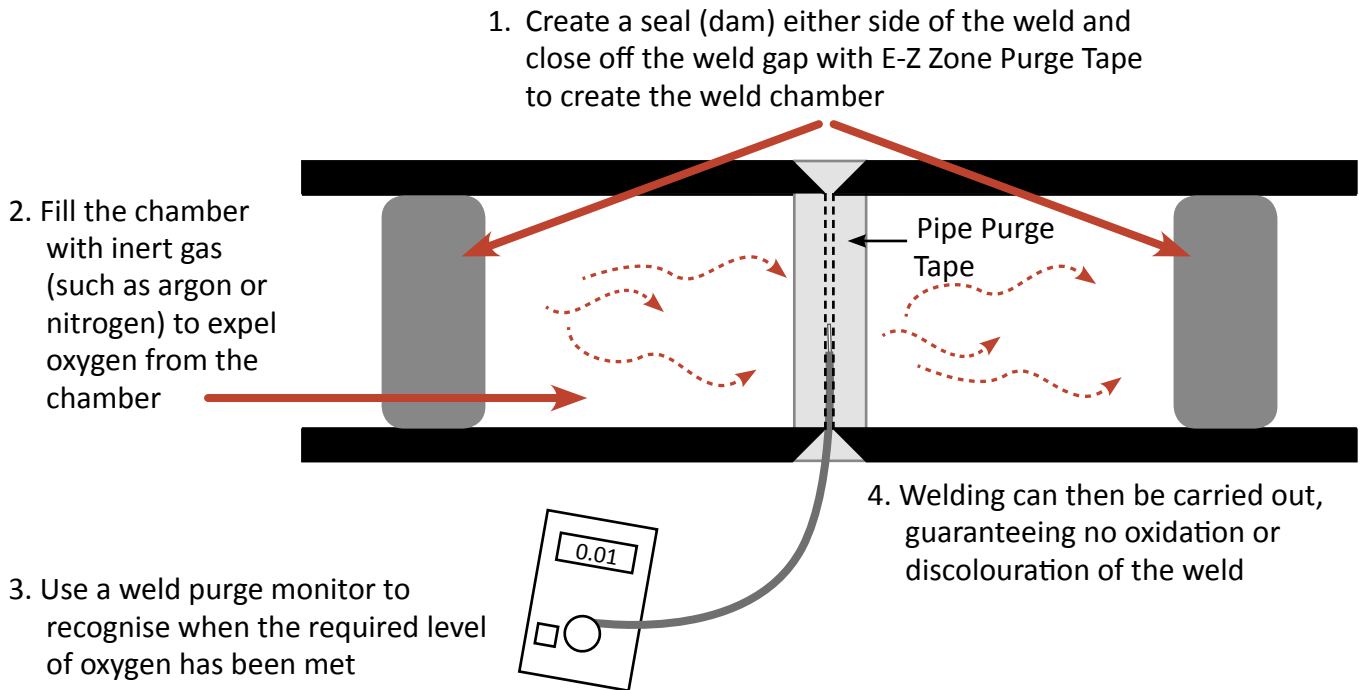

## INDEX

<b>Pipe Purging Equipment .....</b>	<b>33</b>
Why Purge? .....	34
Purge Bag System .....	36
Rapid Purge™ System .....	38
Heat Resistant Purging Systems .....	40
Double Seal Systems .....	42
Flange Double Seal Systems .....	44
Gas Cylinders .....	45
Handy Purge 100 Self Calibrating Weld Purge Monitor .....	46
Handy Purge Pro 5 Weld Purge Monitor .....	48
Pro Purge 1 Weld Purge Monitor .....	49
Trailing Shields .....	50

# TAG PURGE BAG SYSTEM

Sizes: 2 - 24" (50 - 610mm)

## Double Inflatable Pipe Weld Purging Systems

Used for 90% of the traditional pipe weld purging applications to provide bright, shiny, oxide free weld roots. The TAG Pipe Purge System are quick and easy to use providing a very rapid weld purge. High quality materials are used in the manufacture of these systems guaranteeing perfect oxide-free weld roots in very little time.

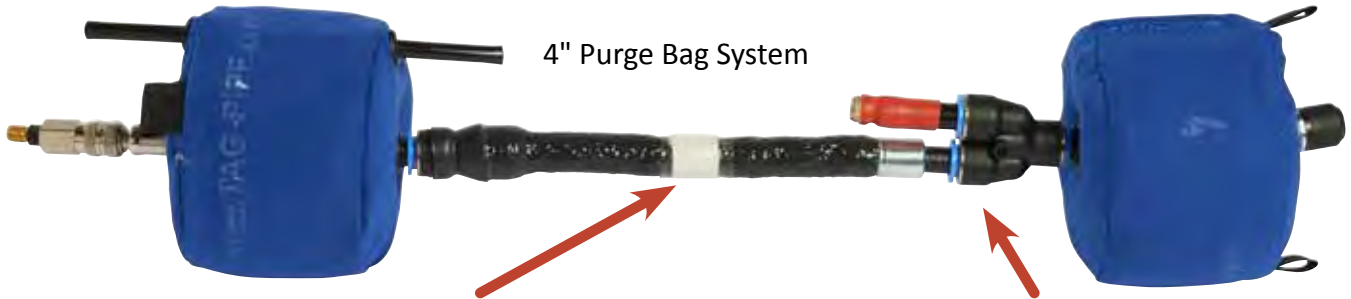

4" Purge Bag System

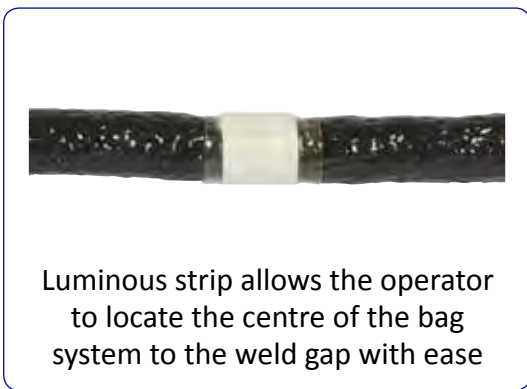

Luminous strip allows the operator to locate the centre of the bag system to the weld gap with ease



The Gas Release Valve is pre-set and sealed, so requires no adjustment

Due to the design of these systems, the volume of gas used to purge is minimised, resulting in significant savings in both time and the quantity of inert gas used. Return on investment can be achieved in as little as just one or two welds. These robust systems can be used over and over again paying for themselves in very little time.

## Features and Advantages

- TAG's Inflatable Pipe Purging Systems dramatically reduce purging times leading to significant savings in labour costs
- **Typical purge times for 4" pipe = 1½ mins; 8" pipe = 4 mins; 12" pipe = 8 mins**
- Ready to use, connects to a dedicated and regulated gas supply. Choose any flow rate up to 20l a min. Through the pre-set purge valve
- Gas pressure control ensures an even positive root bead with no notching
- Quick and easy to install simplifying the process of inert gas purging
- Heat resistant up to 70°C continuously
- Use less inert gas. The volume of purge gas used is less than 2% of that required for a conventional purge



## How it works

The Purge Bag Systems in the range manufactured by TAG are designed around the principle of using 2 dams to create a seal either side of the weld, just far enough away from the weld not to be effected by heat but close enough to the joint to provide the fastest weld purge time. These dams are connected by an armoured spinal tube.

Once ready to start purging, the system is inserted into the bore of the pipe using the luminous strip to centre the system to the weld gap.

When the gas flow is started, the dams inflate and, upon reaching the pre-set pressure, the valve releases the gas gently into the weld chamber, to purge the interspace without turbulence. The Oxygen is removed from the weld chamber through the integral exhaust tubes in the bags. Used in conjunction with TAG's Oxygen Monitors to indicate when the required low level of oxygen has been reached, welding can then commence, with the inert gas enabling the welder to produce an even oxidation free penetration weld bead. Afterwards, the dams are deflated simply by disconnecting the purge gas feed and the system easily withdrawn. The design of these systems means that only one gas connection is required for both dam inflation and weld purging.

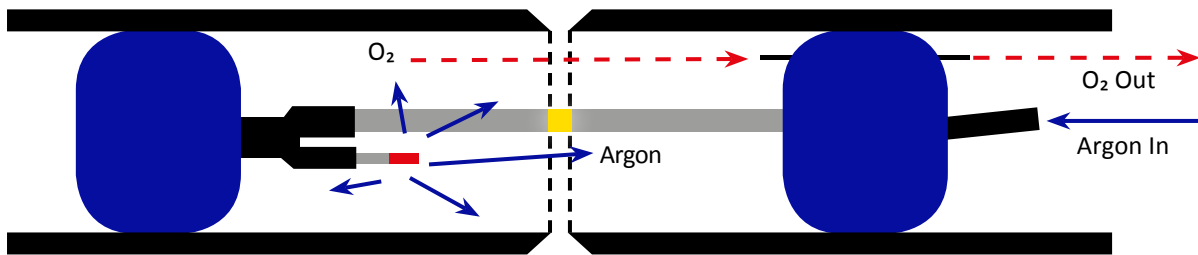

## Sizing and Specification

PART NO.	NOMINAL PIPE SIZE (MM / INCH)		WEIGHT (KG)	INTERNAL DIAMETER RANGE (MM)
PB02	50mm	2"	0.34kg	44 - 57mm
PB03	75mm	3"	0.34kg	58 - 84mm
PB04	100mm	4"	0.34kg	80 - 110mm
PB05	125mm	5"	0.38kg	103 - 135mm
PB06	150mm	6"	0.38kg	124 - 162mm
PB08	200mm	8"	0.90kg	175 - 213mm
PB10	250mm	10"	1.0kg	230 - 265mm
PB12	300mm	12"	1.1kg	265 - 305mm
PB14	350mm	14"	1.3kg	330 - 355mm
PB16	400mm	16"	1.7kg	380 - 405mm
PB18	450mm	18"	1.8kg	430 - 455mm
PB20	500mm	20"	1.9kg	485 - 510mm
PB22	550mm	22"	2.2kg	535 - 560mm
PB24	600mm	24"	2.5kg	585 - 610mm
PBS401	30 meter argon feed hose assembly for The TAG Pipe Purge Bag System to dedicated and regulated gas supply. Fitted at one end with a 3/8" female gas regulator connector and at the other end with a fitting to attach to the inflation hose.			

**\* Larger sizes and specials available on request, however Rapid Purge on pages 32 & 33 strongly recommended over 12"**





# RAPID PURGE™ SYSTEM

Sizes: 8 - 80" (190 - 2044mm)



## Purge larger diameter pipes faster than ever!

Used for stainless, duplex, chrome steels, titanium, nickel and other alloy materials, the TAG Pipe Purge Bag System™ systems enable high speed welding of larger diameter pipe joints that have to be purged.

Designed to enable the user to produce high quality, reliable and repeatable welding of stainless steel tube and pipe joints to ensure a very fast weld purge time and a very high quality weld root, free from oxidation and discolouration.

A 36" diameter pipe will purge to below 0.1% oxygen in less than 10 minutes and all smaller pipes correspondingly faster.

Dramatic savings of time, gas and money can be made by using these systems.

Due to the quality of the materials used, the Rapid Purge™ systems can be used over and over again further reducing manufacturing costs.

As with all of the TAG Pipe Purge Bag System inflatable purging systems, the Rapid Purge™ come with pre-set valves, so are ready to use 'straight out of the box'.

Rapid Purge™ has been developed specifically to enable high speed purging for any pipe welding application.



## Features and Advantages

- **Typical purge times of less than 10 minutes!!!**
- The unique "thru-bore" design of the central sleeve minimises the area to be purged, dramatically reducing the volume of gas required
- Friction free coatings allow easy movement through pipes from one joint to another, even around bends and elbows
- Ready to use, connects to a dedicated and regulated gas supply. Choose any flow rate up to 80l/min. through the twin pre-set purge valve
- A central (glow in the dark) strip allows fast and accurate alignment of the system to the centre-point of the weld area
- The inflatable dams and imbelical hose are covered with a heat resistant material and insulated accordingly for use at temperatures up to 250°C



## How it works

The Rapid Purge™ Inflation Pipe Purging Systems for pipe and vessel purging comprises a tandem inflatable dam system connected by an umbilical hose and collar to reduce the volume being purged.

A gas exhaust valve is installed between the primary and secondary dam, along with an auxiliary argon purge line.

Each Rapid Purge™ System is covered with heat protective material, so that the higher temperatures closer to the weld do not damage the system.

The robust design of the Rapid Purge™ Inflation Pipe Weld Purging Systems allows for many years of repeatable trouble free use.

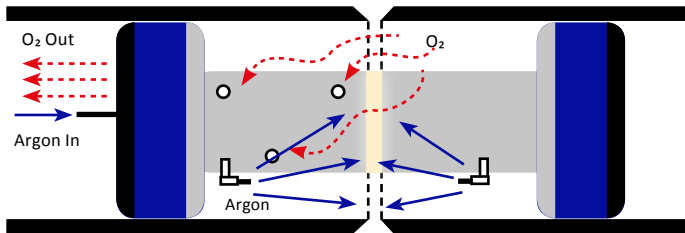

## Sizing and Specification

PART NO.	DESCRIPTION	PRODUCT SIZES (MM / INCH)		EXPANSION RANGE (MM)	WEIGHT (KG)
RP08	Rapid Purge™	200mm	8"	190 - 15mm	1.4kg
RP10	Rapid Purge™	250mm	10"	242 - 267mm	1.7kg
RP12	Rapid Purge™	300mm	12"	291 - 316mm	2.1kg
RP14	Rapid Purge™	350mm	14"	318 - 343mm	2.5kg
RP16	Rapid Purge™	400mm	16"	369 - 394mm	2.7kg
RP18	Rapid Purge™	450mm	18"	420 - 445mm	3.0kg
RP20	Rapid Purge™	500mm	20"	471 - 496mm	3.4kg
RP22	Rapid Purge™	550mm	22"	553 - 577mm	3.6kg
RP24	Rapid Purge™	600mm	24"	572 - 597mm	3.8kg
RP26	Rapid Purge™	650mm	26"	620 - 645mm	4.5kg
RP28	Rapid Purge™	700mm	28"	671 - 696mm	5.5kg
RP30	Rapid Purge™	750mm	30"	722 - 747mm	6.0kg
RP32	Rapid Purge™	800mm	32"	772 - 797mm	8.0kg
RP36	Rapid Purge™	900mm	36"	874 - 899mm	9.1kg
RP40	Rapid Purge™	1000mm	40"	990 - 1015mm	9.9kg
RP42	Rapid Purge™	1050mm	42"	1023 - 1048mm	13.2kg
RP44	Rapid Purge™	1100mm	44"	1125 - 1150mm	13.7kg
RP48	Rapid Purge™	1200mm	48"	1175 - 1200mm	15.0kg
RP54	Rapid Purge™	1371mm	54"	1359 - 1384mm	18.0kg
RP60	Rapid Purge™	1524mm	60"	1512 - 1537mm	20.0kg
RP72	Rapid Purge™	1828mm	72"	1816 - 1841mm	28.0kg
RP80	Rapid Purge™	2031mm	80"	2019 - 2044mm	30.0kg

\* Larger sizes and specials available on request





# HEAT RESISTANT PURGING SYSTEMS

Sizes: 3 - 80" (63 - 2044mm)

## Systems for the fast Purging of High Temperature Pipework

The TAG Pipe Purge Bag and Rapid Purge Systems are both available as heat resistant versions.

Designed for use when high temperatures will be encountered during the process of pipe welding; such as pre-heated pipework, and pipes where very high temperatures are required for welding.

These versions of our inflatable Pipe purging systems are heat resistant up to 350°C (572°F) for up to 24 hours, or up to 500°C for short periods of time, as with the standard systems, the heat resistant systems are available for all pipe diameters from 3 - 80" (75 - 2035mm).

Mirroring the features of the standard range of inflatable purging systems, the heat resistant range comes with a central band for rapid centering of the system to the weld root for the fastest set up times.

The welder can position these systems prior to pre-heating and leave them in place throughout the pre-heating, welding and post-heat treatment cycles, allowing the weld to be purged continuously for up to 24 hours if necessary.

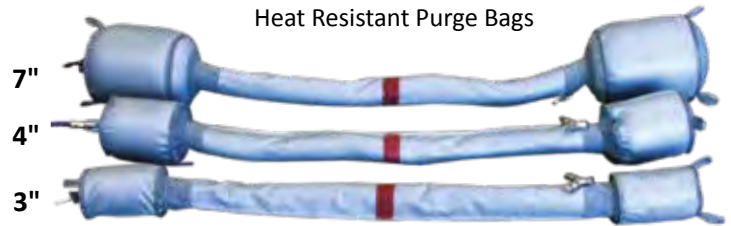

e.g. 7" Pipe will purge in less than 4 minutes!

## Features and Advantages

- Heat resistant up to 350°C (572°F) for up to 24 hours, or up to 500°C for short periods
- Available for all pipe diameters from 3 to 80" (63 to 2044mm)
- Designed to be flexible, for ease of insertion, use and withdrawal from pipes, bends, elbows etc. Suitable for 24 hour cycles including pre-heat, welding and post-weld heat treatment
- A central strip allows fast and accurate alignment of the system to the centre-point of the weld area
- Manufactured to Nuclear Quality Standards with nuclear approved materials, these systems guarantee bright, shiny, coke and oxide-free welds
- Designed and manufactured specifically for the power industry where high strength chrome alloy steels are more frequently used
- Ready to use, connects to a dedicated and regulated gas supply. Choose any flow rate (Purge Bags - up to 20l/min/Rapid Purge up to 80l/min) through the twin pre-set purge valve

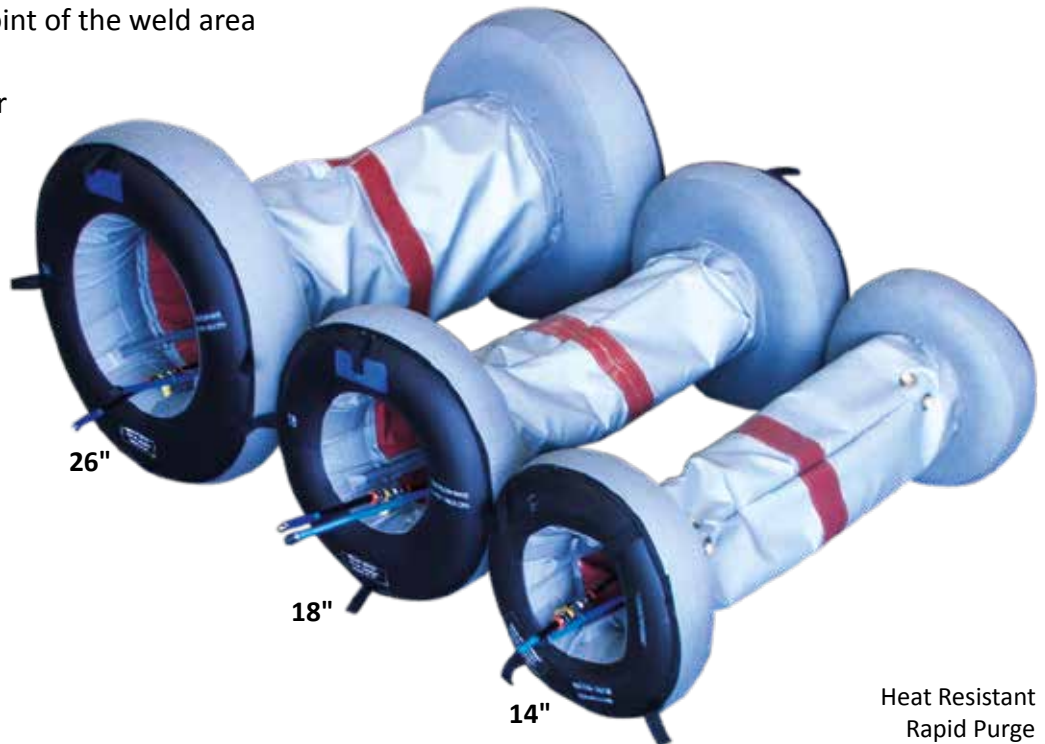

Heat Resistant Rapid Purge  
e.g. 36" Pipe will purge in less than 10 minutes!





## How it works

Both the Heat Resistant TAG Pipe Purge System and the Heat Resistant Rapid Purge™ System work identically to the standard systems, but are made using a purposely designed Nomex and Kevlar mix material to withstand the temperatures typically encountered when welding exotic materials.



7"

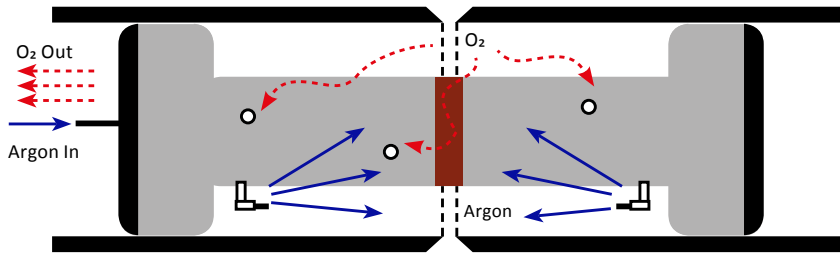

14"

## Sizing and Specification

PART NO.	DESCRIPTION	PRODUCT SIZES (MM / INCH)		EXPANSION RANGE (MM)	WEIGHT (KG)
PB03/HR	Purge Bag Heat Resistant	75mm	3"	63 - 75mm	1.1kg
PB04/HR	Purge Bag Heat Resistant	100mm	4"	92 - 100mm	1.2kg
PB05/HR	Purge Bag Heat Resistant	125mm	5"	113 - 125mm	1.25kg
PB06/HR	Purge Bag Heat Resistant	150mm	6"	138 - 150mm	1.3kg
PB07/HR	Purge Bag Heat Resistant	175mm	7"	163 - 175mm	1.4kg
RP08/HR	Rapid Purge™ Heat Resistant	200mm	8"	190 - 215mm	1.4kg
RP10/HR	Rapid Purge™ Heat Resistant	250mm	10"	242 - 267mm	1.7kg
RP12/HR	Rapid Purge™ Heat Resistant	300mm	12"	291 - 316mm	2.1kg
RP14/HR	Rapid Purge™ Heat Resistant	350mm	14"	318 - 343mm	2.5kg
RP16/HR	Rapid Purge™ Heat Resistant	400mm	16"	369 - 394mm	2.7kg
RP18/HR	Rapid Purge™ Heat Resistant	450mm	18"	420 - 445mm	3.0kg
RP20/HR	Rapid Purge™ Heat Resistant	500mm	20"	471 - 496mm	3.4kg
RP22/HR	Rapid Purge™ Heat Resistant	550mm	22"	553 - 577mm	3.6kg
RP24/HR	Rapid Purge™ Heat Resistant	600mm	24"	572 - 597mm	3.8kg
RP26/HR	Rapid Purge™ Heat Resistant	650mm	26"	620 - 645mm	4.5kg
RP28/HR	Rapid Purge™ Heat Resistant	700mm	28"	671 - 696mm	5.5kg
RP30/HR	Rapid Purge™ Heat Resistant	750mm	30"	722 - 747mm	6.0kg
RP32/HR	Rapid Purge™ Heat Resistant	800mm	32"	772 - 797mm	8.0kg
RP36/HR	Rapid Purge™ Heat Resistant	900mm	36"	874 - 899mm	9.1kg
RP40/HR	Rapid Purge™ Heat Resistant	1000mm	40"	990 - 1015mm	9.9kg
RP42/HR	Rapid Purge™ Heat Resistant	1050mm	42"	1023 - 1048mm	13.2kg
RP44/HR	Rapid Purge™ Heat Resistant	1100mm	44"	1125 - 1150mm	13.7kg
RP48/HR	Rapid Purge™ Heat Resistant	1200mm	48"	1175 - 1200mm	15.0kg
RP54/HR	Rapid Purge™ Heat Resistant	1371mm	54"	1359 - 1384mm	18.0kg
RP60/HR	Rapid Purge™ Heat Resistant	1524mm	60"	1512 - 1537mm	20.0kg
RP72/HR	Rapid Purge™ Heat Resistant	1828mm	72"	1816 - 1841mm	28.0kg
RP80/HR	Rapid Purge™ Heat Resistant	2031mm	80"	2019 - 2044mm	30.0kg

\* Larger sizes and specials available on request

## Purge pipes fast with minimal gas usage

TAG also manufactures The Silicone Double Seal purging system that has been designed to further reduce both inert gas use and purging time. These systems, use silicon discs to form an air tight seal, reducing purge times, and gas usage for maximum efficiency.



There are 2 styles of silicon double seal systems available:

- The Gas Finger system is designed for small pipes and tubes from 16 - 38mm i/d
- The Double Seal systems are made for pipes from ¾ - 12" (16 - 320mm)

## Features and Advantages

- Typical purge times of less than 2 minutes (e.g. an 8" Pipe will purge to below 0.01% Oxygen in less than 2 minutes)
- High quality silicon sealing disks that prevent them tilting or falling over inside the pipe
- Guaranteed gas tight seal
- UV and temperature resistant up to 330°C continuously or 450°C for short periods
- Suitable for purging pipes, elbows and fittings
- The silicon seal units can be separated and used as a gas finger and pipe stopper respectively

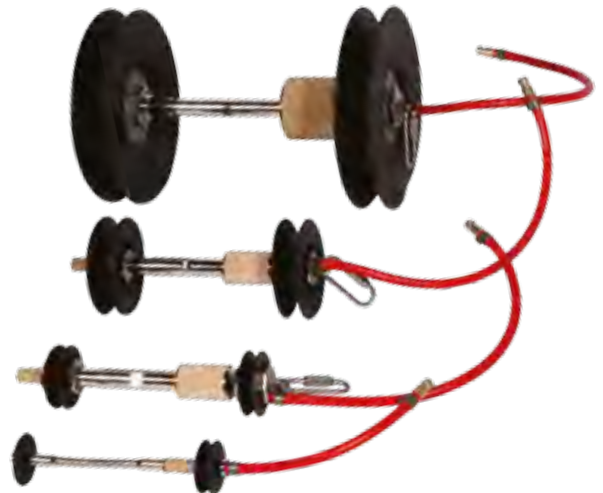

Single Gas Finger for smaller pipe and tubes

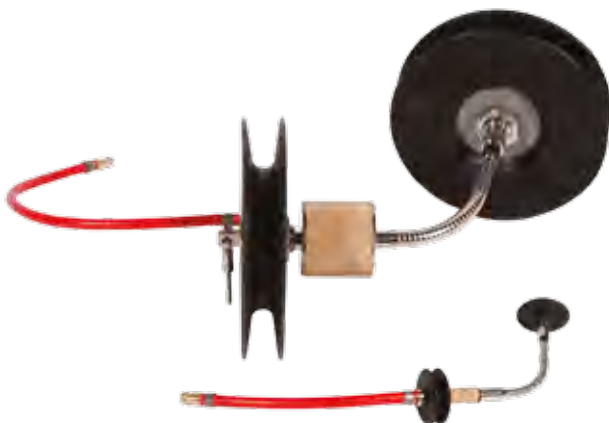

Show with flexible hose connection for purging elbows and fittings.



Available as a kit for 16 - 165mm (DSK16-165)

## How it works

The gas inlet and outlet are provided with twin sealing discs separated by a flexible, rigid or a spring-type tube. The design also guarantees that at least one disc will always remain tight to the pipe wall creating a 100% seal. The discs are UV and temperature-resistant up to 330°C for up to one hour. The gas is diffused into the chamber via the built in sintered diffuser and exits through the exhaust holes in the secondary twin disc unit.

This process of gas diffusion provides an even flow of gas and prevents any gas turbulence behind the weld, thereby minimising the risk of oxygen in the welding chamber while, at the same time, achieving an extremely short purge time. These extremely short purge times result in valuable cost savings in gas and time.

Besides the very short purging time, the Silicon Seal System also offers the possibility to cover various nominal pipe diameters by one pair of baffles enabling highly economic use of the device.

The double seal system can be purchased individually or in kit form for a range of pipe diameters.

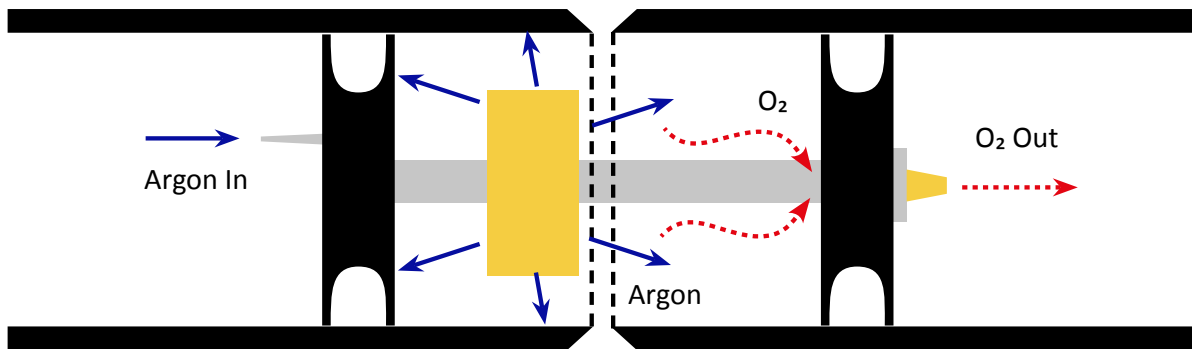

## Sizing and Specification

PART NO.	DESCRIPTION	PIPE I/D RANGE (MM)	HOSE LENGTH (MM)
DS16-19	Flex	16 - 19mm	100mm
DS19-24	Flex	19 - 24mm	100mm
DS24-29	Flex	24 - 29mm	100mm
DS29-34	Flex	29 - 34mm	100mm
DS34-38	Flex	34 - 38mm	100mm
DS38-43	Flexible and Rigid	38 - 43mm	120/60mm
DS43-48	Flexible and Rigid	43 - 48mm	120/60mm
DS47-53	Flexible and Rigid	47 - 53mm	120/60mm
DS52-58	Flexible and Rigid	52 - 58mm	120/60mm
DS64-72	Flexible and Rigid	64 - 72mm	120/60mm
DS78-86	Flexible and Rigid	78 - 86mm	120/60mm
DS90-101	Flexible and Rigid	90 - 101mm	150/100mm
DS100-112	Flexible and Rigid	100 - 112mm	150/100mm
DS120-130	Flexible and Rigid	120 - 130mm	150/100mm
DS124-138	Flexible and Rigid	124 - 138mm	150/100mm
DS144-155	Flexible and Rigid	144 - 155mm	150/100mm
DS150-165	Flexible and Rigid	150 - 165mm	150/100mm
DS197-206	Flexible and Rigid	197 - 206mm	150/100mm
DS209-220	Flexible and Rigid	209 - 220mm	150/100mm
DS246-257	Flexible and Rigid	246 - 257mm	150/100mm
DS260-280	Flexible and Rigid	260 - 280mm	150/100mm
DS290-320	Flexible and Rigid	290 - 320mm	150/100mm
DSK16-165	Complete Kit	16 - 165mm	120/60 150/100mm
DSK16-220	Complete Kit	16 - 220mm	120/60 150/100mm
DSK16-320	Complete Kit	16 - 320mm	120/60 150/100mm



# FLANGE DOUBLE SEAL SYSTEMS

*The perfect solution for purging pipe to flange*

## Purge pipes fast with minimal gas usage

TAG also manufactures The Silicone Double Seal purging system that has been designed to further reduce both inert gas use and purging time. These systems, use silicon discs to form an air tight seal, reducing purge times, and gas usage for maximum efficiency.

## Features and Advantages

- Typical purge times of less than 2 minutes (e.g. an 8" Pipe will purge to below 0.01% Oxygen in less than 2 minutes)
- High quality silicon sealing disks that prevent them tilting or falling over inside the pipe
- Guaranteed gas tight seal
- UV and temperature resistant up to 330°C continuously or 450°C for short periods
- Suitable for purging pipes to flanges

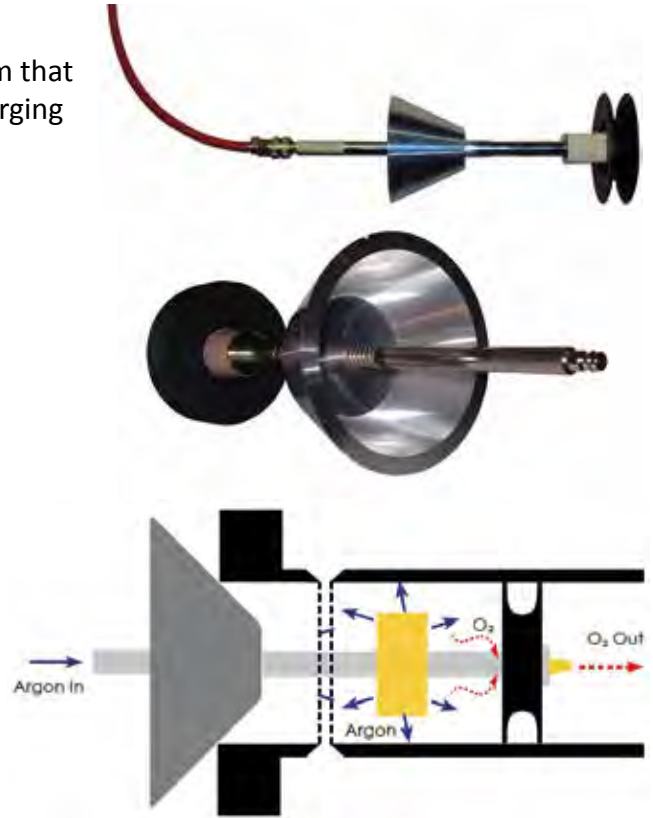

## Sizing and Specification

PART NO.	DESCRIPTION	PIPE I/D RANGE (MM)	HOSE LENGTH (MM)
FDS16-19	Flex	16 - 19mm	100mm
FDS19-24	Flex	19 - 24mm	100mm
FDS24-29	Flex	24 - 29mm	100mm
FDS29-34	Flex	29 - 34mm	100mm
FDS34-38	Flex	34 - 38mm	100mm
FDS38-43	Flexible and Rigid	38 - 43mm	120/60mm
FDS43-48	Flexible and Rigid	43 - 48mm	120/60mm
FDS47-53	Flexible and Rigid	47 - 53mm	120/60mm
FDS52-58	Flexible and Rigid	52 - 58mm	120/60mm
FDS64-72	Flexible and Rigid	64 - 72mm	120/60mm
FDS78-86	Flexible and Rigid	78 - 86mm	120/60mm
FDS90-101	Flexible and Rigid	90 - 101mm	150/100mm
FDS100-112	Flexible and Rigid	100 - 112mm	150/100mm
FDS120-130	Flexible and Rigid	120 - 130mm	150/100mm
FDS124-138	Flexible and Rigid	124 - 138mm	150/100mm
FDS144-155	Flexible and Rigid	144 - 155mm	150/100mm
FDS150-165	Flexible and Rigid	150 - 165mm	150/100mm
FDS197-206	Flexible and Rigid	197 - 206mm	150/100mm
FDS209-220	Flexible and Rigid	209 - 220mm	150/100mm
FDS246-257	Flexible and Rigid	246 - 257mm	150/100mm
FDS260-280	Flexible and Rigid	260 - 280mm	150/100mm
FDS290-320	Flexible and Rigid	290 - 320mm	150/100mm
FDSK16-165	Complete Kit	16 - 165mm	120/60 150/100mm
FDSK16-220	Complete Kit	16 - 220mm	120/60 150/100mm
FDSK16-320	Complete Kit	16 - 320mm	120/60 150/100mm

## Large diameter silicon seal purging systems

The Gas Cylinder system has been designed to further reduce gas usage on larger diameter pipes by localising the purge area to the weld root.

The Gas Cylinders are available for pipes from 200 to 705mm diameter. These tools use two heat-resistant sealing lips to form the seal capable of coping with 300°C for up to one hour. Due to their design, these cylinders have extremely short purge times of 1½ - 2½ minutes for all dimensions.

The Gas cylinders are designed with pull-through balls to enable the unit to be easily retrieved out of a straight section of pipe, or a pipe with a series of bends or elbows.

The purge area is isolated, so there is no need to purge the entire length of pipe to be welded, thereby minimizing gas usage.

## Features and Advantages

- Minimal gas usage, the purge area is localised to the weld root
- Typical purge times of 1½ to 2½ mins
- Strong and robust
- Lightweight aluminium construction

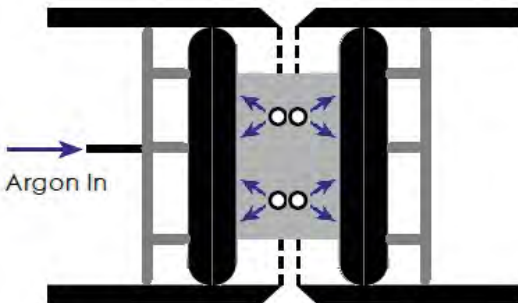

## Sizing and Specification

PART NO.	RANGE (MM)
PC-1	350 - 380mm i/d
PC-2	400 - 430mm i/d
PC-3	440 - 470mm i/d
PC-4	490 - 520mm i/d
PC-5	590 - 620mm i/d
PC-6	645 - 670mm i/d
PC-7	690 - 720mm i/d
PC-8	730 - 750mm i/d
PC-9	780 - 800mm i/d
PC-10	830 - 850mm i/d

\* Larger sizes and specials available on request





# HANDY PURGE 100 SELF CALIBRATING WELD PURGE MONITOR

*Measures oxygen levels down to 0.01% (100ppm)*

**NEW**  
Now Self  
Calibrating

## The entry level, welders' toolbox monitor

Inert gas welding requires the exclusion of oxygen from the weld zone during the welding process. Prior to the welding process, the residual oxygen concentration must be reduced to a required minimum. The Handy Purge is specifically designed to indicate oxygen concentration up to 0.01% and to exactly measure oxygen concentration up to 0.1%. Within this range, it is absolutely safe to weld and produce an oxygen-free weld seam (exceptions include special metals such as titanium, zirconium, etc.).

The Handy Purge can be used both for continuous monitoring during the welding process and for taking samples. Routine inspections for quality control are extremely simplified using this device.

The analyser works with all purge systems and argon welding systems. It is small, easy to handle and has a rugged enclosure.



Replacement sensors and spares available from stock



## Features and Advantages

- Self calibrating
- Minimum waiting time. The device tells you exactly when the residual oxygen concentration of a purge gas is low enough to start welding. You need no longer rely on rough estimations. This saves both time and gas
- Reduced purge gas consumption. Exact monitoring of the residual oxygen avoids unnecessary purge gas consumption and allows you to produce oxygen-free weld seams
- Top-quality weld seams
- Top quality is guaranteed, as too early welding and hence porous, coloured or even charred weld seams can be avoided
- Duplex / Stainless steel. The Handy Purge Weld Purge Monitor can be used for all stainless steel, duplex and certain titanium welding applications
- Eliminates guess work

## How it works

The TAG Handy Purge™ Weld Purge Monitor comes complete and ready to use straight out of the box. It is the most economical user friendly monitor in the market accurately measuring the Oxygen levels in the purged weld areas, to let the welder know when is the correct time to start welding. This reduces waiting time and gas consumption and ensures perfect oxide free welds.

For continuous monitoring during the welding process connect one end of the rubber hose to the sensor adapter and leave the other end outside the purging area to let the residual oxygen flow away from the welding area.

For taking samples connect the stainless steel probe to the sensor adapter. The probe then measures the residual oxygen concentration in the purging/welding area. Also connect the vacuum hand pump to the sensor adapter and squeeze it a couple of times to let a sample of the gas flow to the sensor.

The device's LCD is 13 mm high, which is big enough to identify the displayed values easily also from a distance of a few meters. As soon as the residual oxygen concentration is down to the required minimum, you may start with the welding process.



### TECHNICAL SPECIFICATIONS

Part No.	HP100SC
Measuring range	0.01 % - 20.9 % Oxygen (O2) (100 ppm - 209000 ppm)
Accuracy	at 20% $\pm$ 0.2% at 2% $\pm$ 0.02%
Dimensions	155 x 81 x 38mm
Power source	Battery Type PP3 9V
Display	LCD (Liquid Crystal Display)
Weight	210 g
<b>DIMENSIONS AND WEIGHT FOR SHIPMENT</b>	
Dimensions	310 x 260 x 80mm
Weight	870g

### The kit consists of:

- Handy Purge Weld Purge Monitor
- 1m hose with flow adapter
- Stainless steel probe
- Vacuum hand pump
- Plastic Carry Case
- Instructions
- Calibration Certificate



# HANDY PURGE PRO 5 WELD PURGE MONITOR

*The most accurate hand-held digital oxygen monitor.  
Measures oxygen levels down to 0.0005% (5ppm)*

## For applications where minimal oxidation is critical

The Handy Purge Pro 5 is the ultimate hand-held Oxygen monitor, measuring the level of oxygen in the designated atmosphere down to 5ppm (parts per million)!!! The new Handy Purge Pro 5 Weld Purge Monitor is essential for reading oxygen levels for titanium welding.

The interface option enables the Handy Purge Pro 5 to be connected (via a cable or Bluetooth dongle) to a PC & printer to record the readings. A rechargeable battery pack and multi range power plug are standard features of the Handy Purge Pro 5, and its light weight and ergonomic shape make it the ideal portable instrument for all orbital welding applications.

The unit incorporates an internal pump and is designed for measuring rest oxygen in inert gases such as argon. This unit can be used up to 4 hours before recharging is necessary.

## Key Features

- Measures oxygen levels down to 5ppm (parts per million)
- Rechargeable batteries, standby life approx. 4hrs
- Temperature regulated zirconium cell (maintenance free)
- Graphic display screen changes colour relative to process and function
- Built-in recognition for 110V - 240V power sources
- Portable for remote and difficult access sites using rechargeable batteries (supplied)
- Integrated programmable sound function
- Multi language: English, French, German
- Low permeability measuring hose for accurate measurements
- Data logging of up to 250 entries - Connects via RS 232 interface or Bluetooth

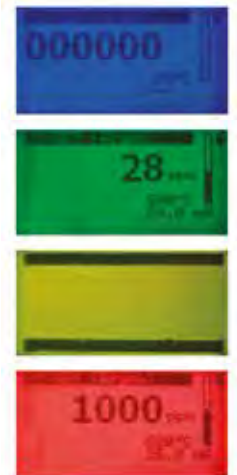

Colour changing display for quick reference to monitor status

TECHNICAL DATA	
Part No.	HPP5
Measuring Range	5 - 999ppm
Dimensions	290 mm x 130 mm x 60 mm (L x W x H)
Weight	0.8kg
Supply Voltage	7 VDC, 2850 mAh rechargeable batteries



Supplied in a durable carry case





# PRO PURGE 1 WELD PURGE MONITOR

Measures oxygen levels down to 0.00005% (0.5ppm)

## The top of the range portable, digital oxygen monitor

- Accuracy to 0.5 ppm
- Temperature regulated maintenance free zirconium cell
- Graphic display (blue & white)
- Built-in recognition for 110v - 240v power sources
- Internal battery power for up to 90min
- Integrated programmable sound function
- Date and time function for data logging
- Easy to use software
- Low permeability measure hose (FPM) for accurate measurements
- Connects via RS 232 interface, Bluetooth, CAN-Bus, AUX (AMI)
- Can be calibrated to ambient oxygen
- Software updateable
- Multi language: English, French, German, Dutch, Czech, Danish
- Data logging up to 250 entries internally or externally on a PC



The Pro Purge 1 Weld Purge Monitor is the ideal tool for many welding applications where critical weld standards are required.

Used for Production of Semi-conductors, Nuclear, Aerospace, Pharmaceutical, Energy, Dairy, Brewery and Food processing where strict welding guide lines to eliminate weld-quality issues associated with atmosphere contaminated welds are required.

The Pro Purge 1 Weld Purge Monitor enables Welders and Welding Engineers on site or in the workshop to precisely monitor rest oxygen levels to the point where precision welding can take place, resulting in “perfect conditions” for consistent high-quality repeatable welds.

The Pro Purge 1 Weld Purge Monitor contains a stabilised zirconium oxide cell with a regulated heater to maintain a cell temperature of 750°C which enables it to accurately measure levels from 206400 ppm down to as low as 0.5 ppm.

The zirconium oxide ceramic sensor in the Pro Purge 1 provides very accurate readings, with a deviation of less than 5% in the 1 to 10 ppm range. This means that its resolution is ½ a part per million (0.5ppm).

The Pro Purge 1 Weld Purge Monitor can be unplugged for up to one hour, before the internal battery must be recharged. Making it ideal for testing weld joints in the shop, or in the field.



Connected via a Bluetooth Dongle with a range of up to 100m to a mobile phone.

Via the phone all relevant data including rest oxygen level, sensor temperature will be displayed. Using simple commands the PRO PURGE 1 can be operated remotely

TECHNICAL DATA	
Part No	PP1
Measuring Range	0.5 - 206,400ppm
Dimensions	220 x 165 x 85cm
Weight	3.3kg
Supply Voltage	110V/240V



Connecting a printer via the RS232 interface. Capable of readout documentation (per second) that can be logged via a printer





# TRAILING SHIELDS

Supplimentary gas shielding for exotic & reactive metals

## Aluminium Trailing Shields

Trailing Shields enable the welder to weld faster, saving time and money allows the production of bright shiny welds. Suitable for welding all types of exotic materials including titanium, nickel and cobalt alloys, stainless and duplex steels and other reactive metals.

Trailing Shields reduce gas consumption due to the gas being isolated to the weld area only and save wasted time, effort and expense by avoiding rejected welds due to oxidation.

Flat models for sheet or plate work are available as well as profiled models for the welding of both internal and external pipes, vessels and tanks. The gas is diffused via a perforated plate.

PART NO.	DESCRIPTION
ATS1	Trailing Shield 1"
ATS1.5	Trailing Shield 1¼" — 1½"
ATS2	Trailing Shield 2"
ATS3	Trailing Shield 3"
ATS4	Trailing Shield 4"
ATS6	Trailing Shield 6"
ATS8	Trailing Shield 8"
ATS10	Trailing Shield 10"
ATS14	Trailing Shield 12—14"
ATS16	Trailing Shield 16"
ATS18	Trailing Shield 18"
ATS22	Trailing Shield 20"—22"
ATS28	Trailing Shield 24"—28"
ATSS	Trailing Shield Straight



## Stainless Steel Trailing Shields

These shields are made from Stainless Steel and utilise a stainless steel sinter-metal gas diffuser. The advantage of the Stainless Steel Shields is they can be used for more than one pipe size, making them more versatile than other simpler systems available.

PART NO.	DESCRIPTION
SSTS3/8	Trailing Shield 3/8"
SSTS0.5	Trailing Shield ½"
SSTS0.75	Trailing Shield ¾"
SSTS1	Trailing Shield 1"
SSTS1.5	Trailing Shield 1¼" — 1½"
SSTS2	Trailing Shield 2"
SSTS3	Trailing Shield 2½" — 3"
SSTS4	Trailing Shield 3½" — 4"
SSTS8	Trailing Shield 5" — 8"
SSTS16	Trailing Shield 8" — 16"
SSTSS	Trailing Shield Straight
SSTSI	Trailing Shield 90° Internal
SSTSO	Trailing Shield 90° Outside





PIPE EQUIPMENT SPECIALISTS LTD

## PIPE STOPPERS

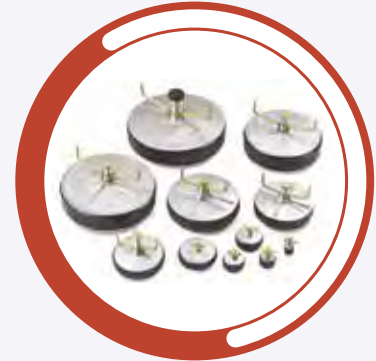
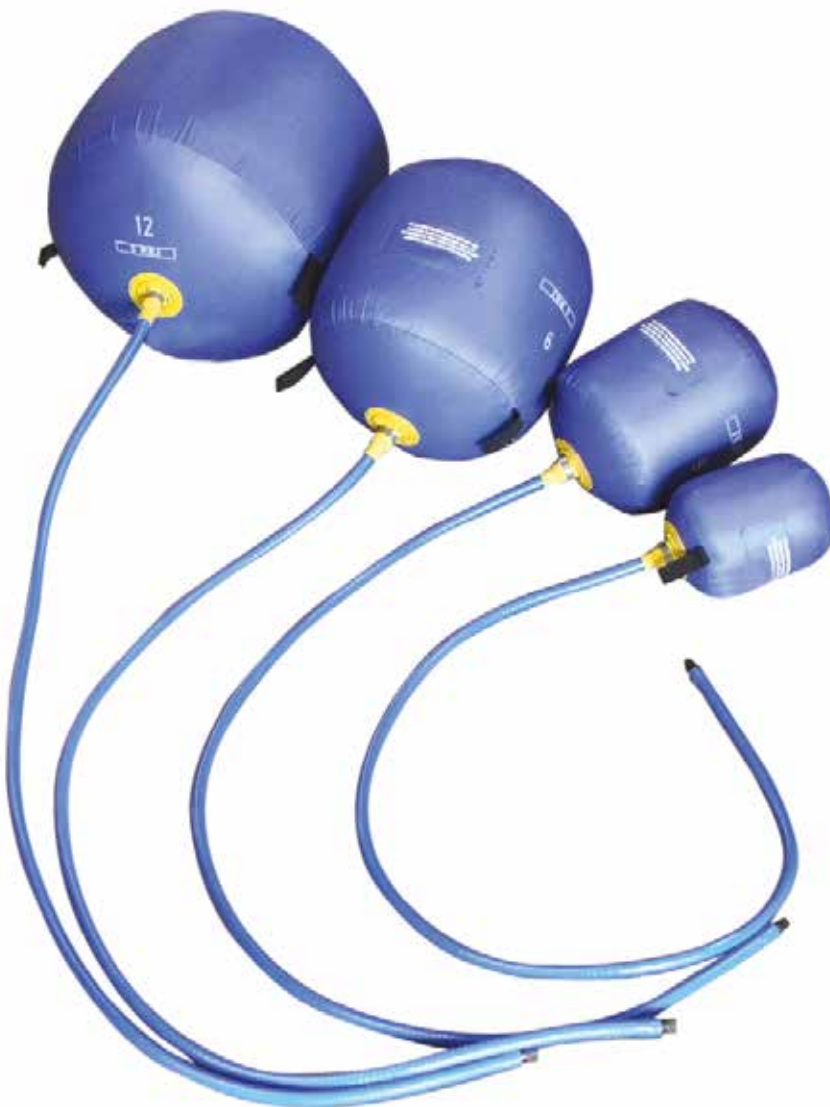

# **TAG** PIPE STOPPERS

Sizes: Up to 72" (1828mm)

## Expandable test plugs for purging and general pipe blocking

Pipe stoppers, or drain plugs as they are sometimes known, are used to temporarily seal the end of a pipe or opening for many different testing applications. Pipe stoppers are mainly used to seal off from water, gases and foreign objects in newly laid pipes, or pipework systems that are under repair.

TAG Pipe Purge System range of Pipe stoppers are available in a number of different styles to suit many applications for pipe sizes from ½ - 72". Special Pipe stoppers are also available for pressure testing.

### How it works

A central spindle/shaft on which two plates are fitted with a natural rubber tyre (ring) between them, a wing nut on the shaft moving the two plates together compressing the tyre and making the seal in the pipe. These stoppers can also be supplied with a hollow shaft version for screwing on standard hose connections or for using fixed or free nipple caps.

Expandable Pipe Stoppers are available in three different types.

### Nylon Plugs



Nylon plugs are the standard 'Drain Plugs' for testing leak tightness of foul water lines at the time of installation.

Furthermore, the range of sizes make these plugs ideal for a number of other applications in the water and gas industries as well as applications in all other industries where pipes are used or where there are holes to be blocked.

### Aluminium Plugs

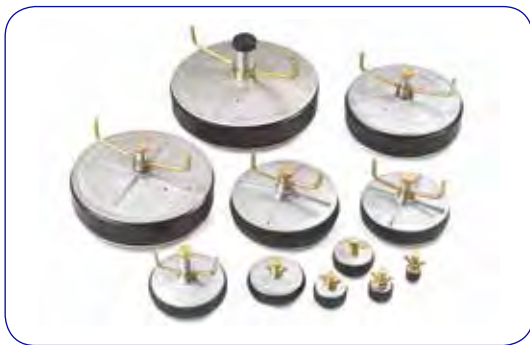

To complement the range of nylon expanding plugs, we offer all sizes of aluminium plugs.

These are provided in sizes from 1.5" upwards and are suitable for more arduous duties such as immersion in chemicals and/or higher temperatures.

### Steel Plugs



TAG Pipe Purge System also manufacture a range of Steel plugs from 1.5 - 72" in diameter.

These plugs are typically suitable for more arduous duties such as long immersion in water and use at higher temperatures or for contact with acidic or alkaline environments for which the Nylon and Aluminium plugs may be unsuitable.

All plugs conform to British Standards BS8005 for low pressure testing and sealing of pipes.

PART NO.	PIPE SIZE INTERNAL NOMINAL DIAMETER		WILL FIT PIPES WITH INTERNAL DIAMETER		MINIMUM INSERTION INTO PIPE	OVERALL LENGTH	DIAMETER OF WATERWAY	MAXIMUM ALLOWABLE BACK PRESSURE	APPROX. WEIGHT
	METRIC	IMPERIAL	MINIMUM	MAXIMUM					
<b>NYLON EXPANDING PIPE STOPPERS SPECIFICATION</b>									
NES18	18mm	¾"	18mm	26mm	30mm	58mm	n/a solid	15p.s.i.	0.01kg
NES25	25mm	1"	25mm	32mm	18mm	51mm	n/a solid	15p.s.i.	0.02kg
NES31	31mm	1¼"	31mm	39mm	19mm	56mm	n/a solid	15p.s.i.	0.04kg
NES38	38mm	1½"	38mm	42mm	36mm	58mm	n/a solid	15p.s.i.	0.05kg
NES50	50mm	2"	48.5mm	62.2mm	36mm	110mm	0.5" bsp	15p.s.i.	0.05kg
NES63	63mm	2½"	65mm	77mm	36mm	110mm	0.5" bsp	10p.s.i.	0.10kg
NES75	75mm	3"	74mm	86mm	36mm	110mm	0.5" bsp	10p.s.i.	0.10kg
NES88	88mm	3½"	82mm	96mm	36mm	110mm	0.5" bsp	10p.s.i.	0.10kg
NES100	100mm	4"	95mm	105mm	36mm	110mm	0.5" bsp	5p.s.i.	0.15kg
NES115	115mm	4½"	114mm	124mm	36mm	110mm	0.5" bsp	5p.s.i.	0.2kg
NES125	125mm	5"	117mm	127mm	40mm	110mm	0.5" bsp	5p.s.i.	0.2kg
NES150	150mm	6"	146mm	155mm	42mm	110mm	0.5" bsp	5p.s.i.	0.25kg

<b>ALUMINIUM EXPANDING PIPE STOPPERS SPECIFICATION</b>									
AES1.5	40mm	1½"	38mm	50mm	45mm	94mm	½"	30p.s.i.	0.17kg
AES2	50mm	2"	49mm	62mm	43mm	90mm	½"	30p.s.i.	0.22kg
AES2.5	65mm	2½"	62mm	77mm	43mm	92mm	½"	30p.s.i.	0.27kg
AES3	75mm	3"	73mm	89mm	43mm	94mm	½"	20p.s.i.	0.31kg
AES3.5	90mm	3½"	84mm	103mm	53mm	96mm	½"	15p.s.i.	0.36kg
AES4	100mm	4"	94mm	110mm	47mm	94mm	½"	10p.s.i.	0.36kg
AES4.5	114mm	4½"	112mm	130mm	56mm	140mm	½"	10p.s.i.	0.47kg
AES5	125mm	5"	125mm	142mm	60mm	95mm	½"	10p.s.i.	0.79kg
AES6	150mm	6"	146mm	168mm	48mm	96mm	½"	10p.s.i.	0.70kg
AES7	175mm	7"	175mm	200mm	64mm	100mm	1"	7p.s.i.	1.92kg
AES8	200mm	8"	193mm	220mm	64mm	100mm	1"	7p.s.i.	1.59kg
AES9	225mm	9"	220mm	240mm	64mm	170mm	1"	7p.s.i.	2.06kg
AES10	250mm	10"	245mm	270mm	73mm	178mm	1"	7p.s.i.	2.52kg
AES11	275mm	11"	274mm	328mm	100mm	200mm	1"	7p.s.i.	3.45kg
AES12	300mm	12"	295mm	325mm	77mm	200mm	1"	7p.s.i.	3.42kg
AES13	325mm	13"	325mm	360mm	120mm	230mm	1"	5p.s.i.	4.75kg
AES14	350mm	14"	350mm	385mm	110mm	215mm	1"	5p.s.i.	6.95kg
AES15	375mm	15"	370mm	410mm	110mm	225mm	1"	5p.s.i.	5.35kg
AES16	400mm	16"	390mm	435mm	110mm	225mm	1"	5p.s.i.	5.9kg
AES18	450mm	18"	445mm	495mm	110mm	225mm	2"	5p.s.i.	8.75kg
AES20	500mm	20"	495mm	550mm	145mm	255mm	2"	5p.s.i.	11.3kg
AES21	525mm	21"	520mm	575mm	145mm	255mm	2"	3p.s.i.	11.8kg
AES24	600mm	24"	595mm	650mm	145mm	255mm	2"	3p.s.i.	15.85kg

<b>STEEL EXPANDING PIPE STOPPERS SPECIFICATION</b>									
SES1.5	40mm	1½"	37mm	50mm	31mm	81.5mm	½"	30p.s.i.	0.16kg
SES2	50mm	2"	50mm	61mm	32.7mm	82.8mm	½"	30p.s.i.	0.18kg
SES2.5	65mm	2½"	51mm	75mm	33.2mm	80.5mm	½"	30p.s.i.	0.26kg
SES3	75mm	3"	73mm	85mm	34mm	80.5mm	½"	20p.s.i.	0.28kg
SES3.5	89mm	3½"	84mm	100mm	41mm	81mm	½"	15p.s.i.	0.36kg
SES4	100mm	4"	94mm	108mm	37.5mm	83.3mm	½"	10p.s.i.	0.41kg
SES4.5	114mm	4½"	110mm	125mm	40mm	83.3mm	½"	10p.s.i.	0.58kg
SES5	125mm	5"	124mm	139mm	37mm	83.3mm	½"	10p.s.i.	0.60kg
SES6	150mm	6"	145mm	160mm	39.7mm	83.3mm	½"	10p.s.i.	0.75kg
SES7	175mm	7"	175mm	200mm	46mm	130mm	1"	7p.s.i.	1.56kg
SES8	200mm	8"	195mm	215mm	37mm	130mm	1"	7p.s.i.	1.47kg
SES9	225mm	9"	210mm	230mm	58mm	150mm	1"	7p.s.i.	1.93kg
SES10	250mm	10"	245mm	260mm	55mm	150mm	1"	7p.s.i.	2.55kg
SES12	300mm	12"	296mm	320mm	85mm	150mm	1"	7p.s.i.	3.72kg
SES14	350mm	14"	340mm	385mm	85mm	210mm	1"	5p.s.i.	6.54kg
SES15	375mm	15"	370mm	415mm	100mm	210mm	1"	5p.s.i.	7.00kg
SES16	400mm	16"	390mm	430mm	95mm	210mm	1"	5p.s.i.	8.45kg
SES18	450mm	18"	448mm	495mm	100mm	210mm	1"	5p.s.i.	10.6kg
SES20	500mm	20"	495mm	550mm	145mm	255mm	2"	3p.s.i.	11.3kg
SES21	525mm	21"	520mm	575mm	145mm	255mm	2"	3p.s.i.	11.5kg
SES24	600mm	24"	595mm	650mm	145mm	255mm	2"	3p.s.i.	15.85kg

\* Larger sizes available upon request





# INFLATABLE PIPE STOPPERS

Sizes: 2 - 80" (45 - 2040mm)

## Single inflatable dams for blocking and testing

TAG offers a range of shapes and sizes of inflatable stoppers, suitable for all applications. Made from a natural rubber bladder covered in waterproof polyurethane coated nylon to prevent friction and static electricity build up.

There are six different types available:

- **Cylindrical** - These are generally used for blocking pipes where access is restricted
- **Spherical** - These stoppers have less contact area than cylindrical stoppers, and are most suited to applications where access is further limited. Due to its shape the spherical inflatable stopper can be used at any angle
- **Square / Rectangular** - These stoppers have a variety of applications, including in air conditioning ducting and venting.
- **Doughnut** - These stoppers require minimal space and are perfectly suited to larger diameter pipes as there is less inflation required
- **Sausage** - The design of this type gives more contact area between the stopper and the pipe wall enabling these stoppers to hold back more pressure
- **Heat Resistant** - These stoppers are made from a specially designed kevlar and nomex mix material to withstand temperatures up to 500°C for applications involving higher temperatures such as pre heating

Each inflatable stopper comes with an inflation hose fitted with a schraeder valve enabling inflation with a standard airline, bicycle or foot pump.

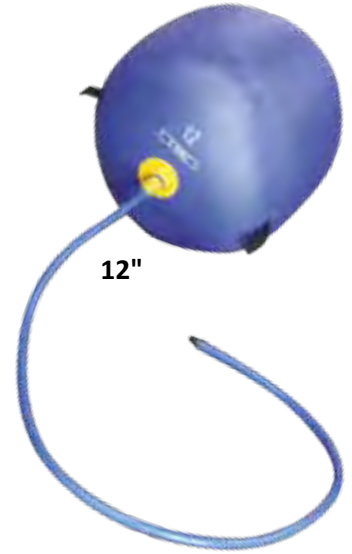

12"



16"

Heat Resistant Stopper



Doughnut Stoppers

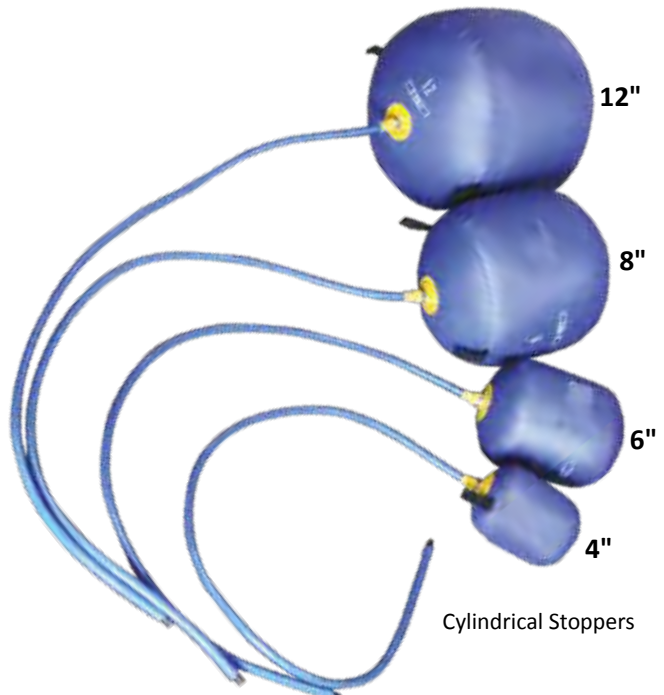

Cylindrical Stoppers

TAG Pipe Purge System inflatable stoppers are supplied as standard with no through tube. Through tubes can be supplied when the stoppers are required for weld purging applications.

When deflated, the inflatable stoppers can be inserted and withdrawn with ease.

## Sizing and Specification

PART NO.	INFLATABLE STOPPER SIZE (MM / INCH)	MIN ID (MM)	MAX ID (MM)
IPS2	50mm / 2"	45mm	55mm
IPS3	75mm / 3"	70mm	80mm
IPS4	100mm / 4"	95mm	105mm
IPS5	125mm / 5"	120mm	130mm
IPS6	150mm / 6"	145mm	155mm
IPS7	175mm / 7"	170mm	180mm
IPS8	200mm / 8"	195mm	205mm
IPS9	225mm / 9"	220mm	230mm
IPS10	250mm / 10"	245mm	255mm
IPS11	275mm / 11"	270mm	280mm
IPS12	300mm / 12"	295mm	305mm
IPS13	325mm / 13"	320mm	330mm
IPS14	350mm / 14"	345mm	355mm
IPS15	375mm / 15"	370mm	380mm
IPS16	400mm / 16"	395mm	405mm
IPS17	425mm / 17"	420mm	430mm
IPS18	450mm / 18"	445mm	455mm
IPS19	475mm / 19"	470mm	480mm
IPS20	500mm / 20"	495mm	505mm
IPS21	525mm / 21"	520mm	530mm
IPS22	550mm / 22"	545mm	555mm
IPS23	575mm / 23"	570mm	580mm
IPS24	600mm / 24"	595mm	605mm
IPS26	650mm / 26"	645mm	655mm
IPS27	675mm / 27"	670mm	680mm
IPS28	700mm / 28"	695mm	705mm
IPS30	750mm / 30"	745mm	755mm
IPS32	800mm / 32"	795mm	805mm
IPS34	850mm / 34"	845mm	855mm
IPS36	900mm / 36"	895mm	905mm
IPS39	1000mm / 39"	995mm	1005mm
IPS44	1100mm / 44"	1095mm	1105mm
IPS48	1200mm / 48"	1195mm	1205mm
IPS51	1300mm / 51"	1295mm	1305mm
IPS55	1400mm / 55"	1395mm	1405mm
IPS60	1500mm / 60"	1495mm	1505mm
IPS63	1600mm / 63"	1595mm	1605mm
IPS67	1700mm / 67"	1695mm	1705mm
IPS71	1800mm / 71"	1795mm	1805mm
IPS75	1900mm / 75"	1895mm	1905mm
IPS79	2000mm / 79"	1995mm	2005mm
IPS80	2035mm / 80"	2030mm	2040mm

\* Larger sizes available upon request



# TAG CUSTOM STOPPERS

*Any inflatable stopper we can make*

TAG can manufacture to any size, shape and material dependant on the clients requirements any style or inflatable stopper, bag or system.

Please see examples below:







PIPE EQUIPMENT SPECIALISTS LTD

## LAYOUT & MARKING TOOLS



# TAG ROTARY EARTH CLAMP

*No more tangled earth leads*

## Features and Advantages

- Attaches and detaches in seconds
- Makes up earth leads three ways - lug, clamp on and bare cable

A simple yet effective device eliminates earth lead twisting, tangling and unnecessary wear.

Provides a stable earth for circumferential welding of pipes and fittings and eliminates weld pinholes caused by poor earthing.

Anti-arc bearings take loads of up to 400 amps.



PART NO.	DESCRIPTION	WEIGHT	
REC1	Rotary Earth Clamp	1.8kg	4.0lbs

# TAG WRAP-A-ROUND PIPE WRAPS

*Easy Pipe Marking*

Economical tool for marking straight lines around pipe, or for use of a straight edge. Made out of flexible gasket material, with good resistance to heat and cold.

Available in two colours, designating material type and service temperature. Gray material is used high temperature applications up to 550°F asbestos free wrap-a-rounds in 3.88" and 5.00" feature a metric scale and pitch chart.

All sizes are printed with a scale in inches, pitch chart, tangent chart and other useful markings. Extra small and special order sizes are unmarked.

PART NO.	DIMENSIONS WIDTH (INCH) / LENGTH (FT)	PIPE SIZE (INCH)
TW3	3.88" / 4ft	3 - 6"
TW4	3.88" / 6ft	3 - 10"
TW5	5.00" / 7ft	4 - 12"
TW6	5.00" / 9ft	6 - 16"
TW3PF	3.88" / ft length desired (priced per ft)	3" - Any
TW5PF	5.00" / ft length desired (priced per ft)	4" - Any
Special length over 10ft up to 375ft		

## Examples

PIPE SIZE (INCH)	PIPE WRAP SIZE (FT)
18"	11ft
21"	13ft
24"	14ft
30"	18ft
36"	21ft
48"	28ft



# TAG FLANGE PINS

Flange Pins are an economical and efficient way to align flanges. For use in ½ - 1½" holes. Quick release design for fast flange alignment. Durable zinc coating finish increases tool life. For use in flange holes up to 1½" deep. Knurled handles increase grip. Lightweight 1.60kg / 3.5lbs.

PART NO.	SIZE (INCH)	DESCRIPTION
TQFFP1	¾ - 1½"	Quick Fit Carbon Flange Pins
TFPSS1	¼ - ¾"	Stainless Steel Flange Pins



# TAG MAGNETIC UNIVERSAL LEVEL

Designed primarily for pipe fitting applications. For all metal work the magnetic feature will offer an extra hand. Multi purpose tool offers 360 degree adjustable dial set level. Includes 2 x 20 pound magnets exerting 50 pound pull this will secure the unit in place on any steel, this enables hands free levelling. For aligning flanges the TAG Magnetic Universal Level is designed to be used with the Quick Flange Pins.

PART NO.	DESCRIPTION
TMUL	2 x 20lbs magnets



# TAG CENTERING HEAD

The TAG Centering Head aids in the setting of centre lines, establishing angles and marks, for butt-ins, locating points inside pipes and tanks, laying out keyways and measuring declivity. Standard model is used on pipe ½" diameter and larger and has a 4" Y-type head fitted with an adjustable dial set level (DSL) and a manually operated hardened centering pin. The large centering head is ideal for pipe 1" diameter and up and has an 8" Y-type head and a DSL. A spring-loaded hardened centering pin eliminates the need for a hammer.

PART NO.	SIZE (INCH)
TCH	Standard ½" plus
TCHL	Extra Large 1" plus



# TAG CONTOUR MARKER

Time saving tool designed to lay out pipe and structural joints. Precise layout of any angle, tees, wyes, crosses, elbows. Eliminated mathematical formulas/cut & try material waste. Consists of X-shape frame, calibrated protractor and a triple jointed marking arm and holder, the protractor is calibrated on both sides, one side in degrees and other side in rise-inches per foot.

PART NO.	SIZE (INCH)
TCM18	1.5 - 18"
TCM48	8 - 48"



# TAG RADIUS MARKER

Models available in four sizes for scribing circles up to 80" in diameter 40" radius. Folding type design three smallest models will fit conveniently into a shirt pocket. Sturdy friction joints maintain rigidity and accuracy, and are made from lightweight, rustproof aluminium for long wear. Soapstone crayon is included. The scribe holder will accept round, square or flat soap stone crayon, pencil or steel point scribe.

PART NO.	RADIUS (INCH)
TRM8	0 - 8"
TRM20	0 - 20"
TRM24	0 - 24"
TRM40	0 - 40"



# TAG FLANGE SQUARE

Designed for the precise adjustment of flanges in tube/pipe construction.

PART NO.	SIZE (MM)
TFSQ300	300mm x 300mm / 30mm x 5mm
TFSQ400	400mm x 400mm / 30mm x 5mm
TFSQ500	500mm x 500mm / 30mm x 5mm

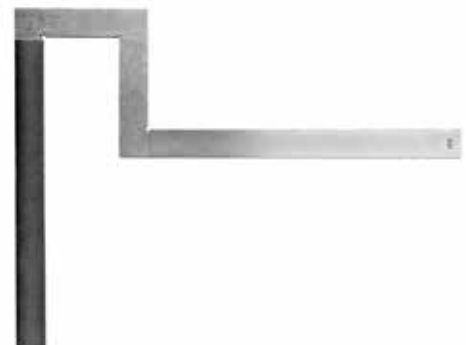



# HANDY POINT PLUS TUNGSTEN GRINDER

*The elite portable grinding machine for tungsten electrodes*

The Handy Point Plus is a portable Tungsten grinder, that is both environmentally friendly and has the ability to grind repeatable quality points on Tungsten electrodes for TIG and plasma welding. The Handy Point Plus is equipped with an integrated, replaceable dust filter, protecting the operator and the environment against the potentially harmful dust produced during electrode grinding. Thanks to its unique electrode holder, the Handy Point Plus is able to grind electrodes as short as 15mm with a standard electrode clamp. Using the special electrode clamp, tungsten electrodes as short as 8mm can be ground. The use of the electrode holder also ensures a precise, centred and repeatable tip. The Handy Point Plus is equipped with an inspection cover enabling the operator to see the grinding operation.

## How it works

The Handy Point Plus is easy to operate, set the required grinding angle, secure the electrode into the holder using the locking device. The electrode is now set so as to minimise the amount of grinding required (0.3mm removal).

The Handy Point Plus is equipped with an eccentric plate, which makes it possible to adjust the grinding position on the face of the wheel, tripling the life of the diamond wheel.

The Handy Point Plus is supplied in a case ready to go, electrode clamps for 1.6; 2.4 and 3.2 diameter tungsten's are included (other sizes are available).

The Handy Point Plus is CE marked and is manufactured to meet all EU directives.

- Integrated exhaustion with a replaceable dust filter
- Triple use of the diamond wheel
- Easy to use, combined electrode positioning and locking devise
- Grinding electrode as short as 15mm
- Durable storage case and lightweight make the Handy Point Plus ideal for working on site

## Specification

HANDY POINT PLUS	TUNGSTEN GRINDER
Part No.	HPPTG1: 110v
	HPPTG2: 220v
Motor	850w
RPM	28000
Weight	2.8kg / 6lbs



Adjustable grinding angle from 15 - 180°



Stand to fix to a bench



Precise adjustment of the stick-out



Eccentric plate triples the use of the diamond wheel





# PRO POINT PLUS TUNGSTEN GRINDER

*The ultimate in electrode grinding for optimal TIG Welding*

The Pro Point Plus is a unique wet tungsten electrode grinding machine, and offers the most precise and environmentally friendly way of preparing Tungsten electrodes for TIG welding.

The Pro Point Plus is constructed with a unique disposable container which automatically collects all toxic dust particles, eliminating the need for any separate extraction systems. The container can then be safely disposed of in accordance with regulations.

A precise angle is paramount to producing the high quality of the weld seams and also increases the number of reignitions between grinding, thus improving productivity and prolonging the life of the electrode.

Using the Pro Point Plus, it is simple to produce the exact angle required. A unique digital angle display and special locking device allows the operator to position the electrode precisely, and the grinding is carried out in the correct longitudinal direction along the electrode.



## Key Features

- 3 grinding positions on the grinding wheel, effectively tripling the grinding life of the wheel
- Longitudinal Grinding of electrodes for the best results
- Cold wet grinding combined with the diamond wheels' high grinding speed ensure that the tungsten electrode always has a polished and even surface
- Easy, safe disposal of hazardous grinding dust in the replaceable cartridge
- Digital angle setting for quick reference and repeatable accuracy
- Tungsten as short as 10mm can be ground ensuring minimal wastage and making the Pro Point Plus perfect for orbital welding applications
- No tools are needed for the easy removal of the waste container for its safe disposal
- Set up the grinder and re-produce the same electrode over and over

## TECHNICAL SPECIFICATION

Part No.	PPPTG1: 110v PPPTG2: 220v
Power Supply	230v / 110v 50 - 60Hz
Electrodes	1.0mm to 4.0mm*
RPM	10000
Grinding Speed	60m/sec
Diamond Wheel	100mm diameter
Min. Grinding Length	10mm
Angles	7.5° - 90° (15° - 180° Tip)
Cutting Length	10 - 175mm
Weight	12.8kg / 28lbs

\* Larger sizes available upon request



Holder can easily positioned to flatten tip at 90°



Digital angle readout



**PIPE EQUIPMENT SPECIALISTS LTD**

**OTHER PRODUCTS INCLUDE...**

**PIPE BEVELLING MACHINES**



**PIPE COLD CUTTING & BEVELLING MACHINES**



**PIPE FLAME CUTTING & BEVELLING MACHINES**

Manual & Manual HD

Magnetic

Auto

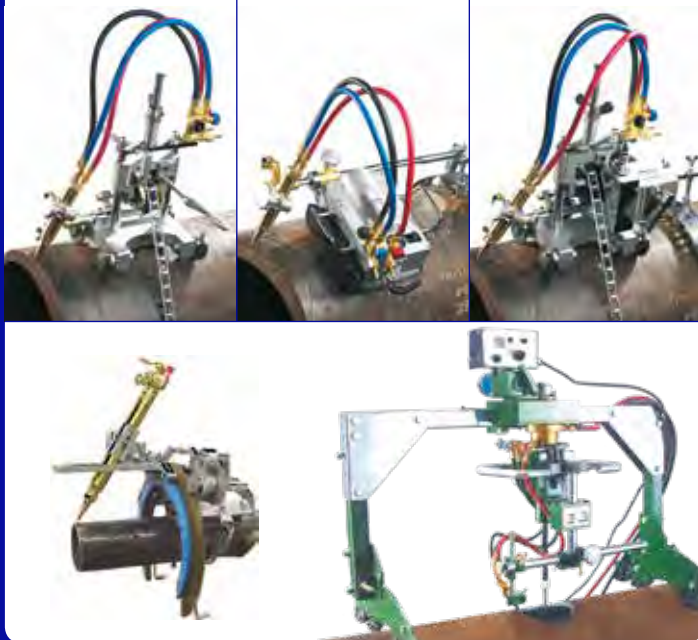

**PLATE BEVELLERS**



Tel: +44 (0)1869 324 144

[www.TAG-PIPE.com](http://www.TAG-PIPE.com)

E-mail: [sales@tag-pipe.com](mailto:sales@tag-pipe.com)





# PIPE EQUIPMENT SPECIALISTS LTD PRODUCTS INCLUDE:

## PIPE BEVELLING MACHINES



## PIPE CUTTING MACHINES



## PIPE ALIGNMENT CLAMPS



## PIPE STANDS AND ROLLERS



## PIPE PURGING EQUIPMENT



## PLATE BEVELLERS



North America

Europe

Asia

Middle East

India

Africa

South America

Australia



### TAG Head Office

**TAG PIPE EQUIPMENT SPECIALISTS LTD**  
Unit 15 & 16 Grendon Industrial Estate, Grendon Underwood,  
Aylesbury, Buckinghamshire, HP18 0QX England  
Tel: +44 (0)1869 324 144 E-mail: sales@tag-pipe.com  
[www.TAG-PIPE.com](http://www.TAG-PIPE.com)

### Your Local Distributor

Представитель в России:  
ООО «ПО ИП»  
Тел: +7 (812)602-77-08  
E-mail: info@poip.ru  
[www.poip.ru](http://www.poip.ru)

## Overseas Branches



### USA Branch

TAG PIPE EQUIPMENT SPECIALISTS INC  
527 Michigan Street, South Houston  
Houston, Texas 77587, USA  
Tel: +1 713 660 1427  
E-mail: sales-usa@tag-pipe.com



### Europe Branch

TAG PIPE EQUIPMENT SPECIALISTS BVBA  
Mosten 13, 9160 Lokeren  
Belgium  
Tel: +32 486 46 62 93  
E-mail: sales-europe@tag-pipe.com



### Middle East Branch

TAG PIPE EQUIPMENT SPECIALISTS FZE  
Al Ittihad Street, P.O. Box 3763  
Dubai, United Arab Emirates  
Tel: +971 (0)50 680 3107  
E-mail: sales-me@tag-pipe.com



### India Branch

TAG PIPE EQUIPMENT SPECIALISTS PVT  
Plot No. PAP 3, D 3 Block,  
Chinchwad, Pune 411 019  
Tel: +91 20 6573 4333  
E-mail: sales-india@tag-pipe.com



### Asia Branch

TAG PIPE EQUIPMENT SPECIALISTS PTE  
Yinhe Bridge West, Beichen District  
Tianjin, China  
Tel: +86 139 2001 5417  
E-mail: sales-asia@tag-pipe.com

*Our company policy is one of continuous improvement. Products may change or vary from those illustrated.*

*Copyright © 2017 TAG PIPE EQUIPMENT SPECIALISTS LTD, All rights reserved.*